

Brave – Door Entry System

Brave NUDV S2

*BNS-00, BNS-01, BNS-02
BNSC-mod, BNSM-mod, BNSKey*



User and Service Manual
Version 1.1

Welcome

Congratulation on purchasing the 'BRAVE NUDV S2 Door Entry system', which is a continuation of the successful 'New Universal Door Entry System' NUDV.

The Brave NUDV S2 Door Entry System is a universal project with the title "BRAVE" with different designs bringing a wider spectrum of functions and possibilities.

Basic functions of the new line

- Urmet NUDV S2 is a modular variation of the new design and has a lot in common with NUDV 1145 (it is possible to use the same mounting box)
- LED backlit name tags
- Two independent relays with 8 setting regimes
- Potential to power an electrical lock on a Door System with a problematic switchboard (replaces the Best Box) and relays regime with constant condition
- Electronic volume control without the need to open the front cover
- Programmable tone detection for call disconnection or repeat calls
- Programming with a DTMF phone or USB cable from a PC and
- 24 digit telephone numbers including * # Flash and Pause
- Exit button
- RTC clock (i.e. automatic day/night switching) – additional module RTC



Manual Version V1.1 17.05.2017

Alphatech spol. s r.o.

Jeremenkova 88

140 00 Praha 4

Tel/fax: 272103334

www.alphatech.cz / info@alphatech.cz

Table of Contents

1	BASIC FEATURES	6
1.1	FEATURES	6
1.2	TERMINOLOGY	7
1.3	BRAVE NUDV S2 VERSIONS AND DIFFERENCES.....	8
1.4	UNIT FEATURES.....	8
1.4.1	<i>Modules</i>	8
1.4.2	<i>Mechanical parts</i>	9
1.4.3	<i>Module compositions</i>	12
1.5	MOTHERBOARD CONNECTION	13
1.6	CONNECTION OF MODULES BNSC(M)-MOD4	16
1.7	BNSKEY KEYBOARD CONNECTION	18
1.8	CONNECTION IP CAMERA.....	19
2	INSTALLATION	20
2.1	ASSEMBLY	20
2.1.1	<i>Front cover disassembly</i>	20
2.1.2	<i>Name tag back lighting assembly and disassembly</i>	21
2.1.3	<i>Inserting the module into the mounting frame</i>	22
2.1.4	<i>Wall mounting</i>	23
2.2	CONNECTION	24
2.2.1	<i>Code relay (COSW)</i>	27
2.3	OTHER ACCESSORIES.....	28
2.3.1	<i>Time Relay</i>	28
2.3.2	<i>Power supply 12V</i>	28
2.3.3	<i>USB Programming cable</i>	28
3	DOOR ENTRY SYSTEM OPERATION	29
3.1	SIGNALLING OVERVIEW	29
3.2	CALLER AT THE DOOR.....	30
3.2.1	<i>Relays regimes</i>	31
3.3	PERSON IN THE BUILDING.....	32
3.3.1	<i>Outbound call</i>	32
3.3.2	<i>Incoming call</i>	33
3.3.3	<i>Door Entry System with keyboard – module BNSKey</i>	33
3.4	ACOUSTIC PATH SETTING	34
4	PARAMETER PROGRAMMING	35
4.1	PROGRAMMING WITH THE HELP OF A PHONE	35
4.1.1	<i>Entry into the programming</i>	35
4.1.2	<i>Parameter programming</i>	35
4.2	PROGRAMMING WITH THE HELP OF A PC – PROGRAMME BRAVESET	36
5	DESCRIPTION OF PROGRAMMABLE PARAMETERS	37

- 5.1 DIRECT DIALLING - MEMORY 37
- 5.2 RELAYS 38
- 5.3 BASIC PARAMETERS 44
- 5.4 TIME PARAMETERS 47
- 5.5 SYSTEM PARAMETERS 51
- 5.6 PARAMETER SETTING HANDS FREE 54
- 5.7 TIME PROGRAMME – AUTOMATIC SWITCH DAY/NIGHT 57
- 5.8 BASIC SETTING AND DELETION 59
- 5.9 END OF PROGRAMMING 59
- 5.10 PARAMETER OVERVIEW 60
- 6 TECHNICAL PARAMETERS..... 64**
- 6.1 ELECTRICAL PARAMETERS 64
- 6.2 MECHANICAL DIMENSIONS 64
- 7 TABLE FOR EASY PROGRAMMING..... 65**

1 Basic features

1.1 Features

- Voice communication is powered from a telephone line
- Impulse and tone (DTMF) options
- Storage of 2 24-digit long numbers per button (including*, #, Flash and pause)
- Automatic Day/Night switch, programmed weekly by a DTMF code on the RTC clock – additional module
- Option to prolong a call with * or #
- Option to connect two independent electronic locks, to open doors
- Potential to use up to 8 relay regimes (for an additional bell, gradual door opening etc.)
- Two codes to disconnect the Door Entry System from a phone
- Two codes to open doors from the phone for 1-impulse and two codes for 2-impulse
- 3 x 6 code locks for each relay (password from door buttons)
- Can be connected electrically secure lock on the first switch (serial activation code)
- Option to connect an exit button
- Option to disconnect a call by the repeated pressing of a button
- Option to switch on a 'baby call' regime (no number dialling)
- Option to switch on a regime to suppress the DTMF connection from the microphone
- Option to switch on a 'ticking' sound into a call to announce another call
- Option to switch on acoustic signalling for relay connection
- Option to set the number of rings before connecting a call
- Programmable parameters for tone options Flash length and Pause length
- Programmable parameters for acoustic signalisation
- Programmable parameters for tone detection
- Electronic volume setting without the need to open the front cover
- Option to power from an internal 12V supply (replaces Best Box)
- Easy setting HW with the help of a DIP switch
- Several default level options
- Programmable with PC, via USB cable, and remote DTMF programming
- Integrated regulated heating of the PCB
- Switchable name tag lighting
- Unit earthed for better protection against static electricity

1.2 Terminology

Telephone line	Analogue (2 conductors) connecting to a public telephone network (public line) or to a local telephone system (local line).
Line connection	The start of a telephone connection (the same as picking up a phone handset).
Line disconnection Option	End of connection (the same as replacing a phone handset). DTMF - a tone option combination of two tones (chooses also special signs * and #, uses breaking the loop Flash) Impulsive – option by breaking the loop (chooses only digits)
Incoming call	Connection between a Brave and a phone made by selecting an option on the phone. The Brave connects the call after set number of rings. The Brave can be programmed from the phone following a connection by inputting a password.
Outbound call	Connection between the Brave and a phone made by choosing an option on the Brave (i.e. Pressing a button).
Call connection	Signalled when following the dialled number is picked up. This signal is not available on an analogue line, but the ringing tone ends and a connection begins. It is difficult to identify the exact moment this occurs.
Code lock	Function for relay connections by inputting a combination of up to 10 buttons or keyboard keys (after pressing the key symbol)
Code relay	between Doorphone Brave and the electric lock can be connected code relay (COSW - CodeSwitch), which is located at the lock and lock activates only when is the same the specified serial combination of the Brave and set the code on the board relay (COSW).
External code	Combination of 10 buttons or keyboard keys (after pressing the key symbol) for a relay connection. External = being input on the Brave outside the building
Internal code	Digits combination dial from phone for relay activation (DTMF). Internal = dial by phone – inside building (phone connected to other PBX extension)
modul RTC	Additional module with RTC an backup battery



The manufacturer continuously improves the product firmware. The technology used allows you to upload to Brave the latest version of the firmware any time using a standard computer with BraveSet and USB cable. The latest version of the firmware is available at <http://www.alphatech.cz>

1.3 Brave NUDV S2 versions and differences

The **Brave** door entry system is conceived as system that provides a final solution based on a modular design. The features and parameters that are available to, and can be set, differ for each version of the **Brave**. It is therefore necessary to set the parameters for all versions including any add-on parameters for each version.

Brave NUDV S2 uses almost all the parameters in the basic version, the only thing not included is the RTC clock and therefore function associated with this circuit (automatic day / night - a week program). Brave NUDV S2 can be extended to small additional module RTC and thereby expand the desired function to the maximum.

1.4 Unit features

Basic module - Brave NUDV S2 contains two panels:

- First motherboard with all the trailers and construction elements.
- Second top plate connecting a PC expansion modules.

The basic module is equipped with one, two or no buttons.

It is possible to extend the basic module with anything from four to 99 buttons.

1.4.1 Modules



Basic module
BNS-02
c:1148/22



Basic module
BNS-01
c:1148/21



Basic module
BNS-00
c:1148/20



Button module
BNSC-mod4
c: 1148/15



Button module
BNSM-mod4
c: 1148/14



Button module
BNSKey
c: 1148/46



Add on module
Blanking plug c:1148/59



Add on module
tag card c:1148/50



Add on module
RFID c:1148/45



Module analog Camera
k:1748/40



Easy Door Controller
k:1148/EDC



IP-camera
k:1148/ipcamera

1.4.2 Mechanical parts

The illustrations below show the mechanical part options required for a 2 module system. For other amounts the end number is 1 – 4, for two modules the number is 2. There is maximum of 4 modules in one column, large compositions contains maximum of 3 columns (12 modules). For even larger compositions it is possible to put blocks of 12 modules next to or above each other.

Assembly box for below plaster

(same as 1145)



MK-1
k:1145/51



MK-2
k:1145/52



MK-3
k:1145/53



MK-4
k:1145/54

Mounting frame and cover frame for assembly above and below plaster



k:1148/61



k:1148/62



k:1148/63



k:1148/64

Frame for below plaster



k:1148/711



k:1148/712

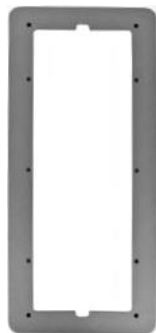

k:1148/713

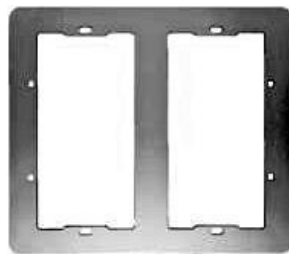

k:1148/724

Roof for below plaster (same as 1158)



k:1148/611



k:1148/612



k:1148/614

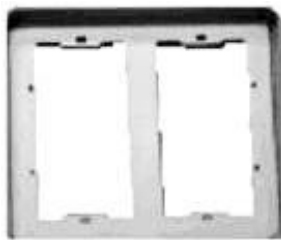

k:1148/624

Rain cover – compact for assembly on plaster

Mounting frame and cover frame is not include in Rain cover



k:1148/311
+1148/61



k:1148/312
+1148/62



k:1148/313
+1148/63



k:1148/314
+1148/64



k:1148/324
+2x1148/62



k:1148/326
+2x1148/63

1.4.3 Module compositions

The modules are installed into the frames so that modules 1-4 are in one column (row) and the whole composition is then attached to this column.

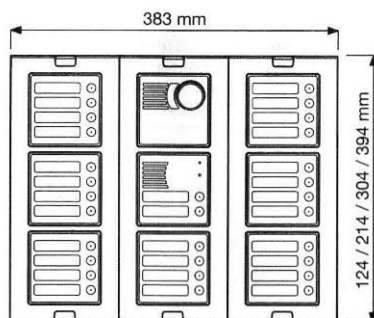
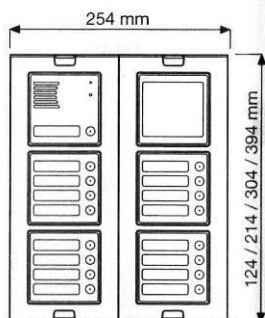
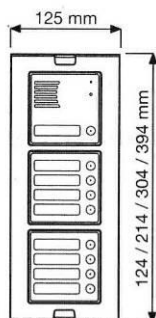

1.5 Motherboard connection

All functional and add-on parts are marked with a red circled number, the description for which are on the following page.

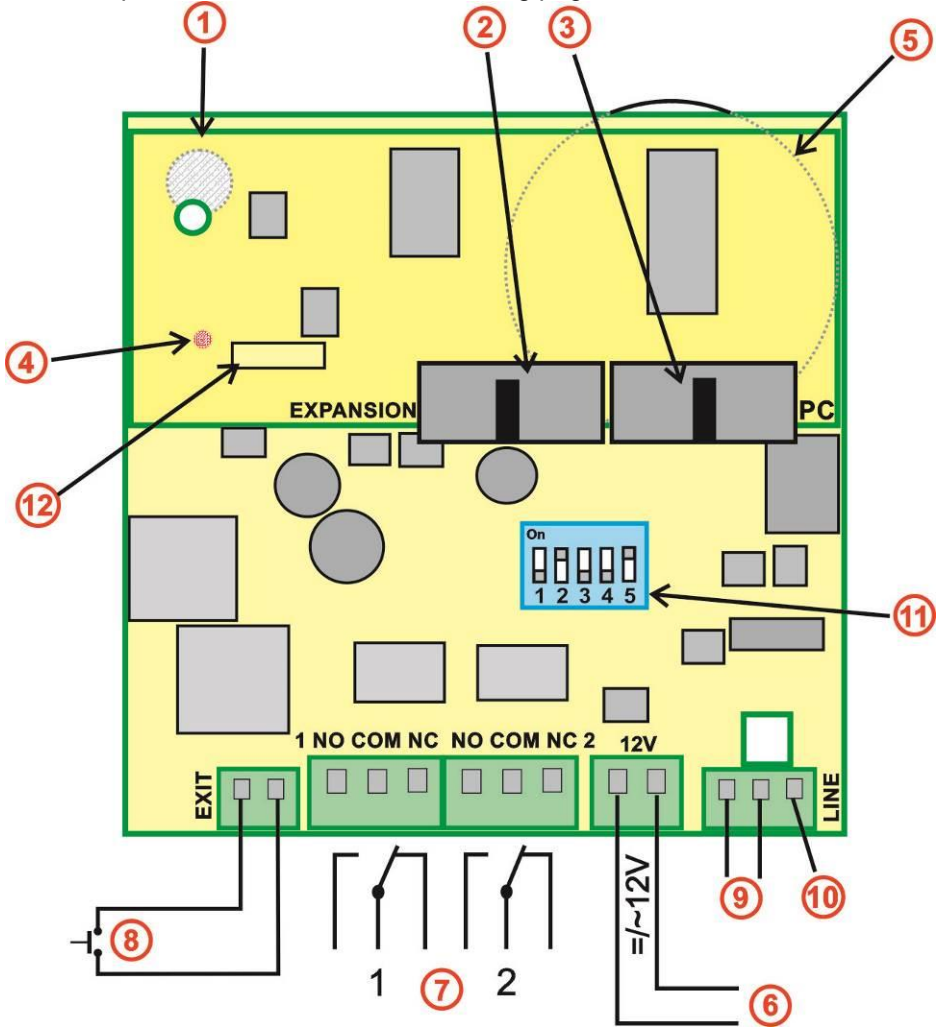

Pic. 1 Brave NUDV S2 door entry system motherboard

1. **Microphone** (placed on the lower part of the motherboard) – be careful of the rubber seal of the microphone when changing the name tags, as the improper assembly may affect the acoustics.
2. Connection **expansion buttons** modules and keyboard
3. Connection point for a **PC** USB cable (as per NUDV).
4. **LED** indicator (placed on the lower part of the motherboard)
5. **Speaker** – at the lower part of the motherboard
6. **12V AC/DC power supply** for:
 - relay controls
 - motherboard heating
 - name tag back lighting
 - internal power supply (DIP 3 a 4) and
 - power supply for exit button circuit.
7. **Relays** – are galvanically isolated, load is max. 48V, max. 1,5A on switch 1 is available relay function code (COSW - CodeSwitch) (see page 27)
8. **Exit button** - works in current loop circuit, length of connected conductors can be as long as 500m. To work there must be a 12V power supply connected to the terminal (6).
9. Analogue **telephone line** (the polarity is not important).
10. **Earth** – connection for an earth against static electricity – protecting the electronics of the door entry system and telephone system.
11. **DIP switch:**
 - 1 = Service – for use when the password is forgotten. Incoming call then enters straight into programming where you can set new password (don't forget to switch it off again!) and
 - 2 = Heating – starts integral heating to stop condensation during changeable temperatures.
 - 3 = Integral power supply
 - 4 = Integral power supply – always switches 3 and 4 at the same time. Power supply is used from terminal 12V (6) and is used for 2 reasons:
 - use of regime 7 or 8 – constant connection or disconnection of a relay is possible only with integral power supply. Don't forget to also set parameter 64.
 - connection of the door entry system to the phone line switchboard that has problem with power supply after switching on (Siemens). This regime fully replaces the use of internal box Best Box and
 - 5 = Name tag back lighting (switches on/off LED name tag back lighting next to the button)
12. Connects an optional module RTC to extend auto day / night

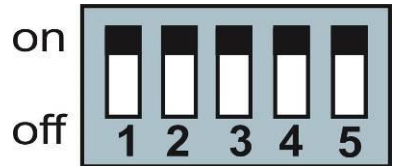

Power supply - terminal (6):

The 12V power supply can be **unidirectional** or **alternate**, the polarity is unimportant, the maximum off-take from a 12V supply is 250mA.

It is possible to use the power supply to power up an electronic lock, but it is recommended that 12V/1A is used.

It is also possible to use a **24V unidirectional** power supply. Although it is mainly used during installation, where there already is a power supply and, for example, for attendance systems or sliding gates. The motherboard heating has regulated element with a limited performance, other circuit are sized for 24V power supply. You cannot use and alternate power (AC) supply, only unidirectional. Polarity is unimportant.

Supply voltage on the terminal (6) is necessary for the following functions:

- relay control
- motherboard heating (DIP 2 switches on, regulation of current according to voltage and temperature)
- name tag back lighting (DIP 5 switches on)
- internal power supply of door entry system electronics (DIP 3 and 4) – replaces Best Box (solution for switchboard Siemens). If there is a constant power supply, it is possible to carry on relay regimes 7 and 8 (be careful about parameter 64)
- powering up the exit button circuit

Exit button –terminal (8):

The exit button is used for a direct relay control. On each relay it is possible to set up a switch on one or on two impulses. Button (terminal (8)) is connected in a current loop circuit powered up from a 12V (terminal (6)). It is possible to connect it with a cable as long as 500m.

Connection expansion buttons modules and keyboard:

This bus enables you to connect additional buttons (up to 99) including a keyboard. Apart from the series data the bus also contains a power supply for the nametag back lighting. Each button module can process up to 8 buttons (the **BNSC-mod4** contains 4 buttons and you can connect another 4 buttons with the **BNSM-mod4**). It is also possible to connect a keyboard in place 1 – 8 on the BUS, additional buttons can also be added after that. To simplify a place can be determined as – how many flat cables are between the keyboard and the motherboard, which is where the keyboard is connected.

1.6 Connection of modules BNSC(M)-mod4

Button add-on modules are either active **BNSC-mod4** (contains electronics) or passive **BNSM-mod4** (mechanical module Urmet – only buttons). The first add-on next to the basic module must be an active module (4 buttons). An active module is connected with a flat cable **K1** - 10 wires (be careful about the direction of the connection). Next in line is passive module – connected with 5 conductors, the 2 yellow wires are used for powering the name tag back lighting (12V).

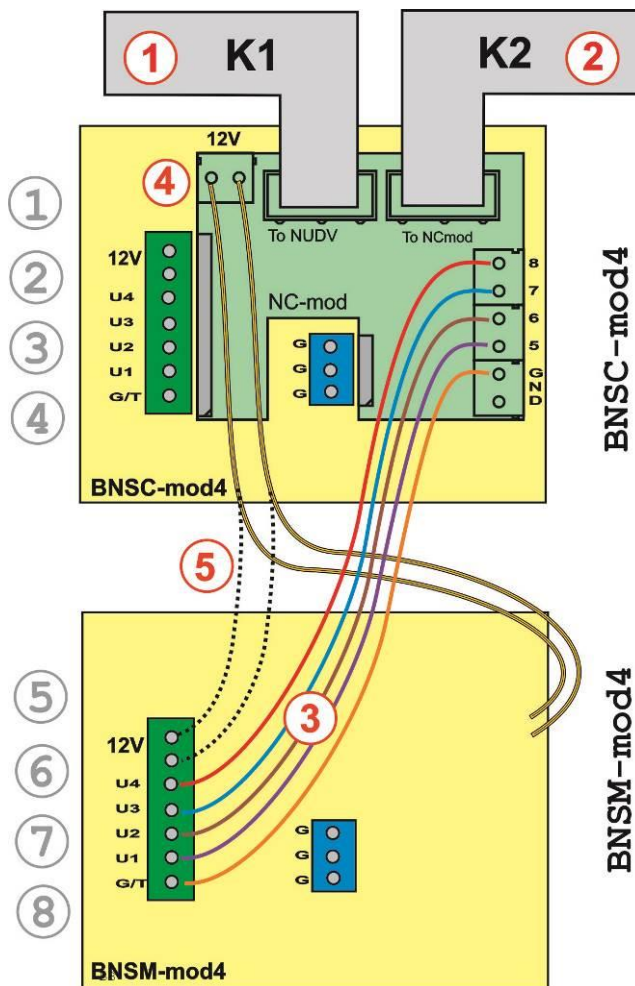

Pic. 2 Connection of BNSC-mod4 and BNSM-mod4

Module **BNSC-mod4** has 4 buttons and contains the electronics for connection to the basic module, or to a BNSC-mod4/BNSKey. This module is connected with a flat cable – the buttons and back lighting are already connected. On the module there are also terminals for connecting 4 additional buttons as well as the power supply for the name tag back lighting (following BNSM-mod4). Module **BNSM-mod4** is always connected to the previous (i.e. in line from the basic module) BNSC-mod4. The connection is not prepared and it will be necessary to connect it with conductors – see Pic.2. Connections with flat cables are made easier by the connector locks, which prevent turning, but the connectors are directional – "To basic module" is the direction to the basic module, "To expand module" is the direction to the end of line (on last BNSC-mod4 / BNSKey).

Pic.3 shows the position of the keyboard place. In this example the keyboard BNSKey is connected in second place (there are 2 cables between the keyboard and basic module).

Pic.3 also shows the position of the button module with a keyboard connected. The number of buttons on the basic module is set with parameter **6#** – see page 51.

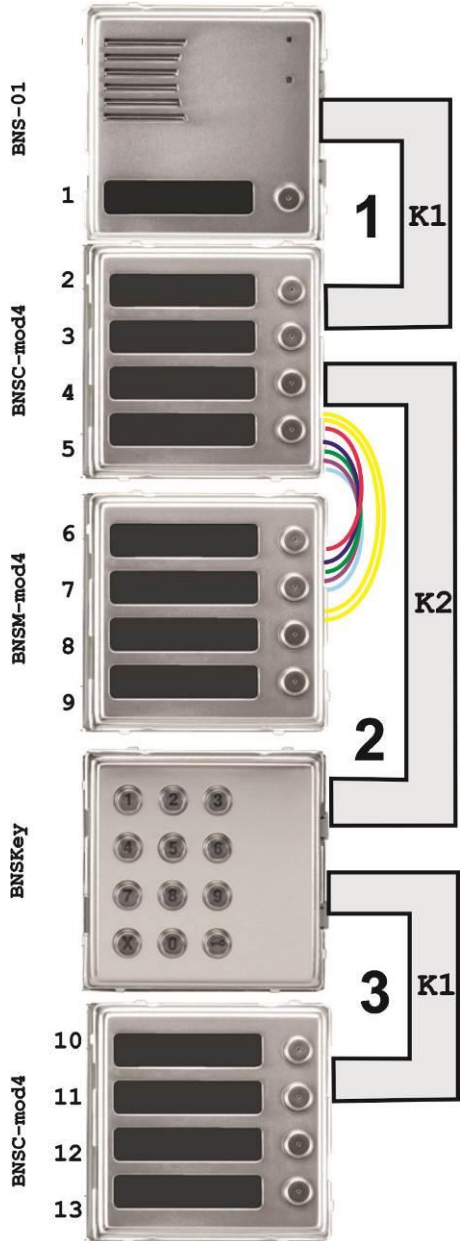



Pic. 3 Interconnecting of modules Brave NUDV S2

1.7 BNSKey keyboard connection

Connecting the keyboard module is done with a flat cable like BNSC-mod4, the only difference is that the keyboard module can only be connected to the first 8 places following the basic module, which means that there can be only 58 buttons before the keyboard. The buttons can continue up to a 99 after the keyboard.

Be careful when programming – It is necessary to determine exactly where the keyboard is connected (parameter **48** – page 42)

Options are chosen by pressing the numbered buttons, to input a password press the button with key symbol  first, to disconnect press the 

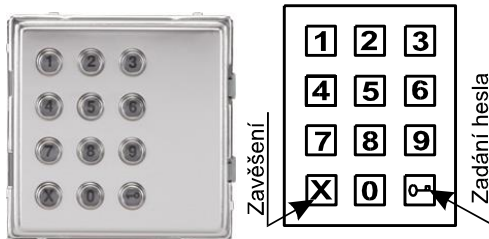

and the door system will disconnect a call or cancel the process of (Cancel).



The keyboard function is activated by parameter **48**.

- If the parameter is **48=0**, all the buttons (including the keyboard if connected) connected to the basic module behave like normal buttons and the first 10 buttons can be used as a lock for a code.
- If the parameter is **48>0**, then there is a keyboard in the system. The number behind parameter 48 determines the keyboards place – for ease, it is the number of flat cables between the keyboard and the basic module. It is then only possible to input the lock for a code from the keyboard after pressing the key button .

The keyboard has 2 basic regimes for dialling the phone numbers (parameter **49**).

- Direct choice of phone numbers – press numbers on the keyboard like you would on a phone (max. 24 digits)
- Choice from the door system's memory – press only 2 digits on the keyboard i.e. a memory address (01- 99). This option saves the connected buttons, as it is easier to use a smaller number of buttons for direct dialling from the memory regime if you have a larger number of participants.

Note: button 1 on the basic module uses the same memory of telephone number as option 01 on the keyboard – there memory for up to 99 day-time numbers and 99 nighttime numbers, the keyboard uses the same memory as the buttons!

You can set the DTMF dialling option with parameter 40 during a phone call. Because on the keyboard the button  is used purely for disconnection and cancelling, you can set option * / # under button  for parameter 40.

1.8 Connection IP camera

IP Camera is a stand-alone module that uses power from the power supply for the camera castle. It connects via flat cable K3. Connection examples are shown.

IP camera

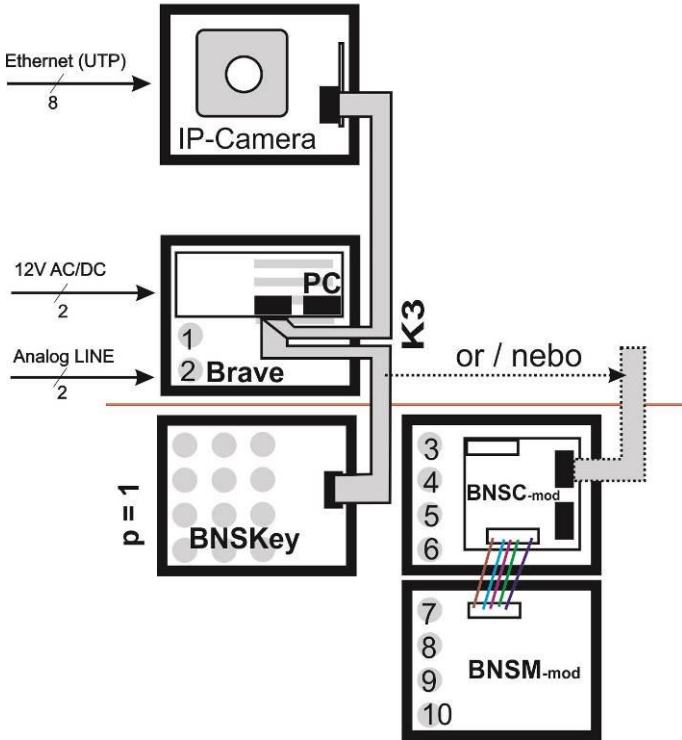

2 Installation

2.1 Assembly

2.1.1 Front cover disassembly

The cover plate is fastened with two screws with cross recess. These two screws are hidden under the caps on the top and bottom (as well as for the 1145 NUDV). Mounting frame is the same as the model 1145 NUDV S2 (1148) differ only in the mounting frame.

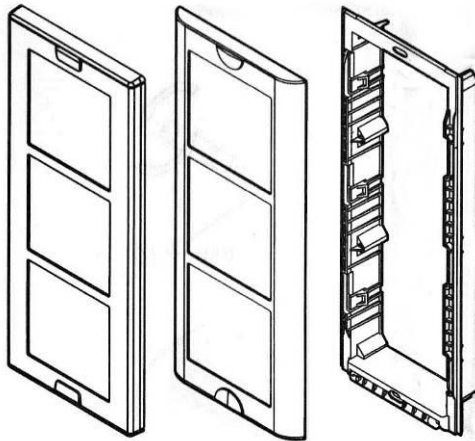

Fixing frame

1148

1145

mounting frame

Removing the panel is done by extracting the fixing holders as per picture (on the side of the panel, in a forward direction)

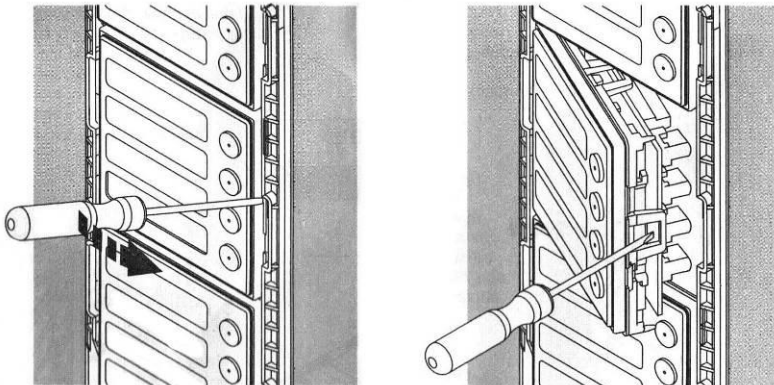

2.1.2 Name tag back lighting assembly and disassembly

There are 2 lugs on the side of each module, after pulling them back you can slide the front panel out.

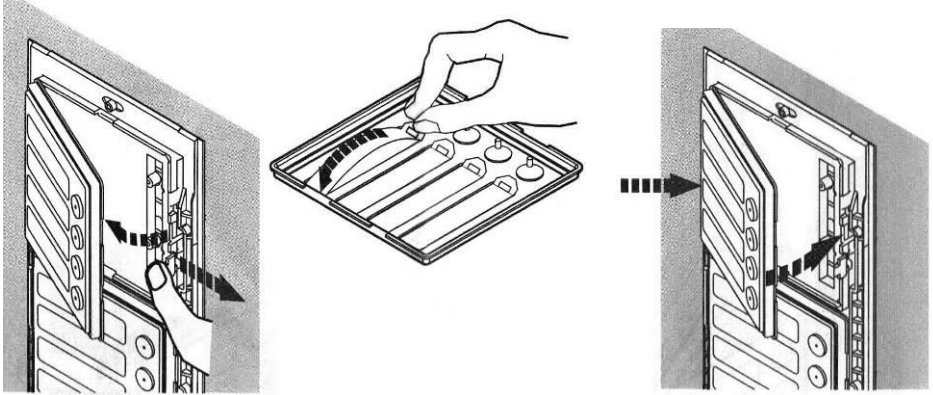

Paper tags are held to the front panel with a plastic holder. Follow the same procedure to place the panel back, being careful to insert the two lugs on the left carefully.

You can fill the tags in MS Excel – the file for which can be downloaded from www.alphatech.cz or from the installation CD.

The tag dimensions are 55 x 12,5 mm.

2.1.3 Inserting the module into the mounting frame

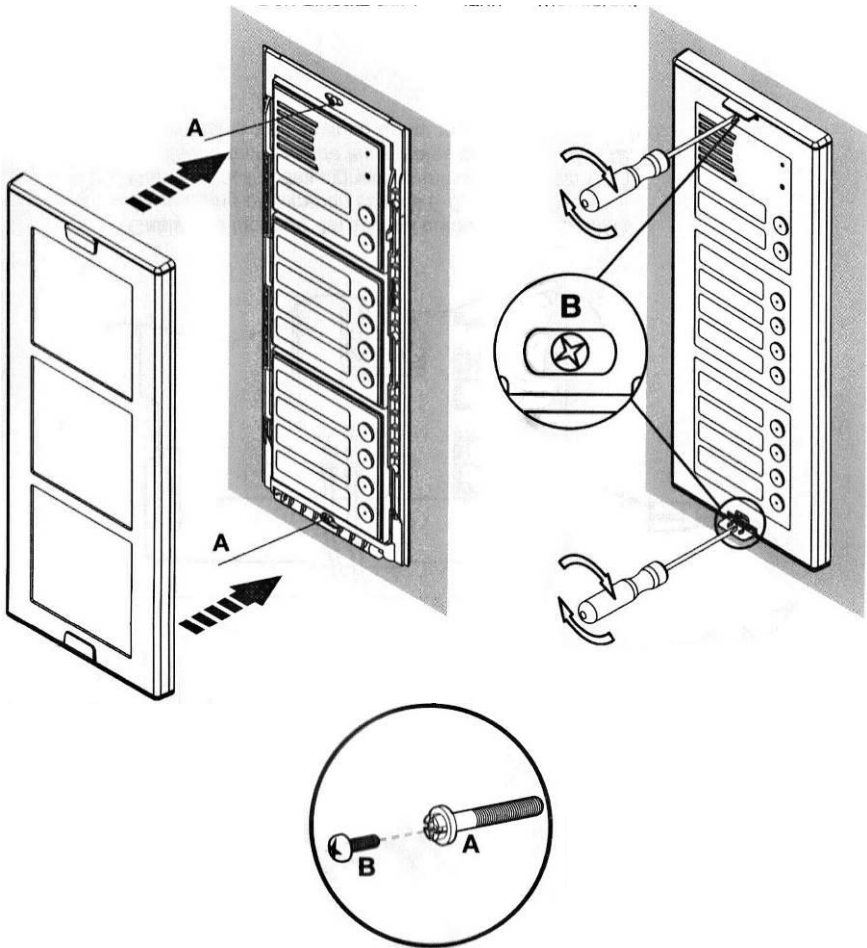

First screw on the bottom part of the frame. You can fit the frame into the fitting box 1145/5x system (original NUDV)

Then screw on the top part of the frame.

Screws A for fixing of the mounting frame are hollow with internal thread for the screws B, which serves for fastening the mounting frame.

2.1.4 Wall mounting

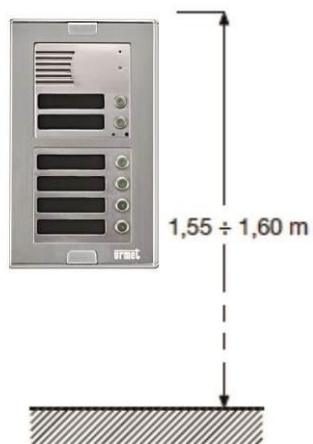
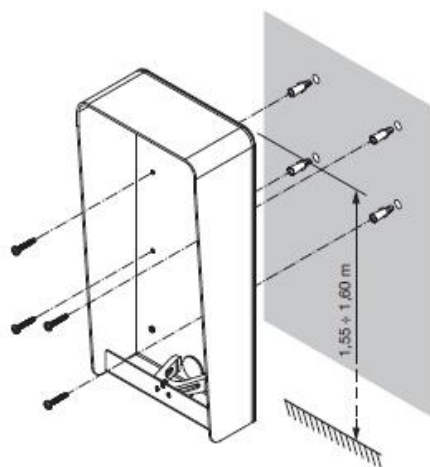

2.2 Connection

The basic function (connection and disconnection of a call) only requires a **phone line** connection - LINE (9) on Pic 1. The line is connected with 2 conductors (a,b) and has a generally voltage of 24V - 60V, short circuit 20mA - 60mA. During connection the line voltage is 7V - 10V.

Line connection - The Brave NUDV S2 broadcasts a sound (Reset) 🎵 (chapter 3.1 page 29) if it has previously been disconnected from the line for any length of time. Brave NUDV S2 is an analogue door entry system designed for connection to an analogue phone line. The polarity of the phone line is unimportant. Brave NUDV S2 works according to the setting of technical parameters (chapter 6).

Parallel connection - is not recommended, as parallel connection with another door entry system or phone line only causes technical problems. Also it is not possible to use different devices for a line switch over (intelligent adaptor plugs etc.)

For the motherboard heating, name tag back lighting, powering up the current loop of the exit button and for relay controls it is necessary to connect a 12V power supply (6) Pic. 1. A 12V power supply can be unidirectional or alternate, although the polarity is unimportant, max. off-take from 12V is 250mA. It is possible to use the power supply to power up an electronic lock, but it is then recommended that a 12V/1A supply is used. When connecting to an existing system, i.e. to an attendance system or sliding gates, you can also use the systems power supply or a unidirectional 24V power supply, NOT alternate, polarity is unimportant.

Relays (7) (Pic.1) have many different uses, and ether connection examples are showed on Pic.4. You will need to connect a 12V power supply for the system to function correctly. The door entry system is designed so that all parts are galvanically separated. The telephone line is separated from the power supply and the relay contacts are also separated galvanically from the other door entry system parts. This prevents problems with lead-ins and interactions.



Under no circumstances use 120V or 230V direct current (DC)!
This can be solved by the use of contactors (power relays) as per Pic.4. (6)

Examples of relay connection are shown on the following pages, these are not an exhaustive list of possible connections, but they illustrate how to connect each circuit (red circles with numbers = example numbers).

1. Basic connection – 2 electric locks and the potential to control two doors independently (relay regime 1 and 2 $m=1$) or the gradual opening of a door (relay regime 2 - $m=5$).
2. Two sources – the potential to use two power sources, one for the Brave NUDV S2 and a second for an electric lock. Electric lock 2 is connected inversely (i.e. emergency fire door).
3. Combination of a door with an electric lock and a sliding gate.
4. Extends the previous example to two doors with gradual opening (this function is set in Time Relay - external module).
5. Combination of an electrical lock and an add-on bell. The relay for an add-on bell can be in regime $m=4$ (each button switches on for a set length of time) or in regime $m=6$ (switches on from one pre-set button for a set length of time).
6. Light switch $m=3$ (i.e. lighting to the building) with relay 1. Relay 2 – controls, for example, heating according to day/night regime $m=8$ (only version with module RTC). It requires an external power supply (DIP 3 and 4), and also it is necessary to use contactor (Brave NUDV S2 **cannot** switch 230V!).

The examples shown are only for illustrative purposes only.



Note: Door entry system Brave NUDV S2 is designed in such a way that it is possible to connect 10-18V AC or 11-24V DC to the terminals 12V (polarity is unimportant). The motherboard heating system has a regulator so that resistors won't burn out at a higher voltage.

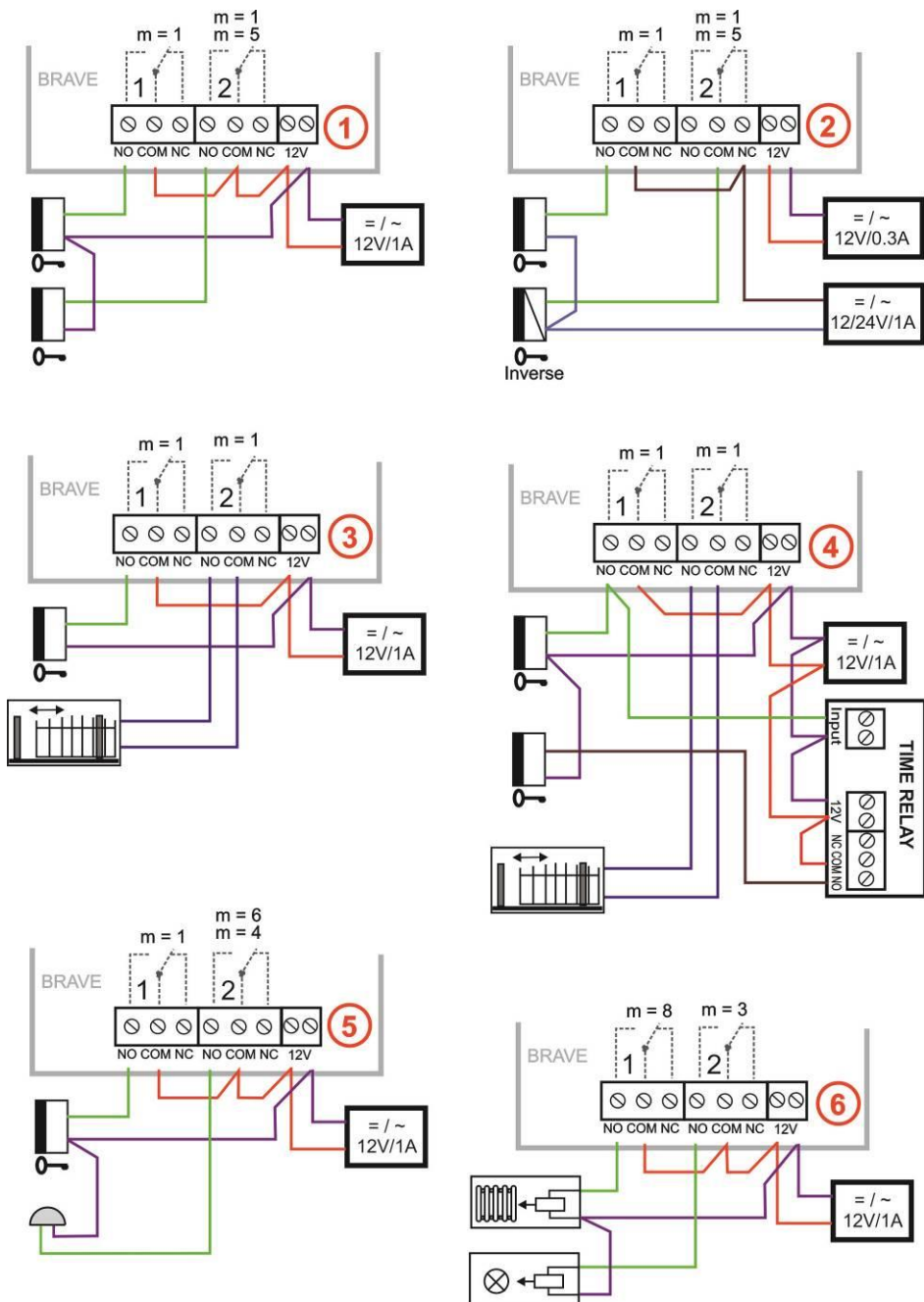

Pic. 4 Examples of relay connections

2.2.1 Code relay (COSW)

For the first switch is available function code relay (COSW CodeSwitch). It serves primarily to secure transmission of information by switching the electric lock. When using this function is not possible connecting or disconnecting the voltage at the terminals to lock this lock activated. Activation is performed only when positive result compared serial information transmitted between Brave and the board code relay

Brave is set in several codes to activate the relay code. Relay can be activated codes for one or two impulses can differentiate activated from the phone (DTMF) or from keys (keyboard). The last option is the activation code in another mode switch than the lock.

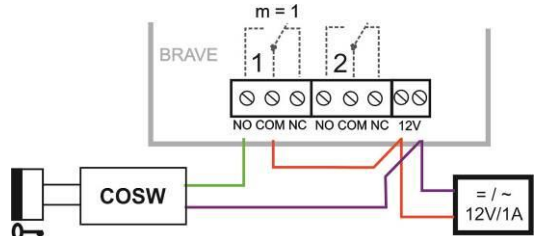

The code information is 8 bits, but the code is 4 bits with security 4 bits which is total of 8 bits. Practically, this is performed so that after activation the switch is first transmits the serial code, and if they agree, so code relay connects the electric lock.

 The code relays can be connected in parallel to increase the number of switches, but can never combine connections electric lock and the code relay parallel!

2.3 Other accessories

2.3.1 Time Relay

The time relay enables wider functionality of the relays. It is a separate product and detailed instructions can be found at www.alphatech.cz

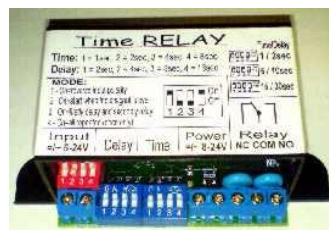

2.3.2 Power supply 12V

A 12V/A alternative power supply is recommended for the Brave NUDV S2. This is not a part of delivery and must be ordered separately. Further details of power supplies and electric locks can be found at www.alphatech.cz



2.3.3 USB Programming cable

The USB cable is the same as that used for the NUDV door entry system or NLLW communicators. The USB drivers can be found on the web site www.alphatech.cz















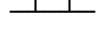

3 Door Entry System Operation

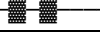
The Brave NUDV S2 door entry system's functions are set by establishing parameters (see the chapter on parameter programming page 35).

3.1 Signalling overview

Brave NUDV S2 acoustic signals that occur during its operation. Samples of sounds can be listened to in the setting programme 'BraveSet'.

State	Tones	Tone frequency
Pick up line type 1		980-1333-1650
Disconnection of line type 1		1650-1333-980
Pick up line type 2		800-1067-1200-1333
Disconnection of line type 2		1333-1200-1067-800
Confirmation of command from the phone		800
Ticking during a call		
Notice about the end of a call		1333
Relay switch signal		Modulated
Entry into programming from the phone		980-1067-1180
Programming from the phone		Modulated
Parameter confirmation		800
Entry into programming from the PC		980-1067-1180
Line connection (Reset)		1850-1067-1850
Error (generally something is not right)		800
Empty memory (no number is programmed)		1300-2100

It is useful to know what tones the Brave NUDV S2 plays during installation as it will assist in the analysis of its state and operation. The sounds can be turned off in several levels (*parameters 61,62,63 and 65*).

To play and listen to the sound signals go to: www.alphatech.cz/zvukova-signalizace-3.html

3.2 Caller at the door

The door entry system's buttons are labelled in the same way as normal doorbell buttons. Visitor finds the appropriate name (for example Mr Smith) and presses the button. The Brave will pick up a line, "plays" the pick up line tone (if it is not prohibited *para.62*) and dials the phone number saved under that button (*parameter 1 or 2* depending on system regime). From the Brave's speaker a ringing tone will be heard and Mr Smith's phone will ring. As soon as Mr Smith picks up he can talk to his visitor. If an electric lock is also connected to the Brave, Mr Smith can press a DTMF code on his phone and let visitor in. If he puts down the phone the Brave will disconnect. If the call lasts longer than the pre-set limit (*parameter 52*), 10sec before disconnection the Brave will send a line disconnection tone, but Mr Smith can dial * or # (*parameter 42*), to prolong the call for the length of time set in *parameter 52*.

The dialled number depends on the regime mode, which is set in the system (*parameter 47*):









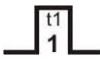

- **Regime Day/Night** = if the system is in 'Day' mode, it dials the number set in *parameter 1*, if the system is in 'Night' mode, it dials a number set in *parameter 2*. The switching over of regimes manually is set in *parameters 45,46*. In version it is possible to activate Day/Night modes automatically and numbers dialled are selected according to a time in the table (*parameters 00-06*).
- **Regime 2 groups** of numbers = the first press of the button always dials a number set in parameter 1. Following the repeated pressing of the same button, when it detects a busy tone (10sec after choice), or after a pre-set number of rings (*parameter 56*) the system dials a number from the second group (*parameter 2*). After another press of the same button the system will again dial the number from the first group (or after detecting a busy tone on the dialling of a number from the group 2 the repetition ends).

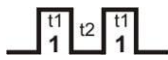
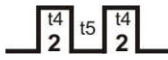
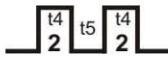
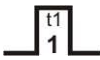

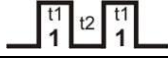

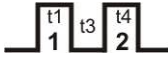
If a visitor presses the button after the system has picked up, the system will disconnect for a length of time as set in *parameter 54* before it picks up the line and dials a new number. The number choice takes place either by tone (DTMF) or impulse according to the setting in *parameter 41*. There is one more option, disconnection of line after repeat pressing of the same button (*parameter 4**).

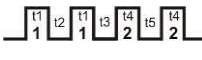
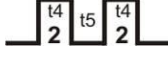
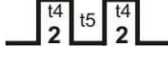
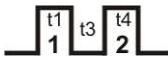
It is possible to control a relay switch (**code lock**) with the first 10 buttons. If visitor at the door presses buttons in the correct combination according to a pre-programmed code (*parameter 32-34*) and the length of time between presses isn't greater than the pre-set time (*parameter 53*) the system picks up, switches the appropriate relay (if it is set in mode $m=1$ or $m=5$) for the length of time given in *parameter 37 or 39,30* and then disconnects.

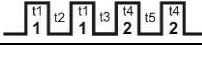
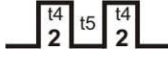
Relays can switch on one or two impulses depending on control code with the length of time between impulses set in *parameter 30*. See Tab. 1.

3.2.1 Relays regimes

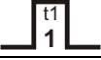
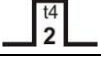
Regime m = 1 (parameter 3111 and 3121)			
Action	Note	Parameter	Relay
Evaluation of correct internal code from the buttons	According to setting Day/Night	3211-3215	
		3311-3315	
		3411-3415	
	According to setting Day/Night	3221-3225	
		3321-3325	
	According to setting Day/Night	321*	
		331*	
	According to setting Day/Night	341*	
322*			
According to setting Day/Night	332*		
	342*		
Internal code from the phone	Option to choose 1 or 2 digits of code 2 digit code is basic and it is possible to shorten it by using * in the first place of code during programming	351	
		352	
		361	
		362	
Regime m = 5 (parameter 3125)			
Action	Note	Parameter	Relay
Evaluation of correct internal code from the buttons	According to setting Day/Night	3211-3215	
		3311-3315	
		3411-3415	
	According to setting Day/Night	3221-3225	
		3321-3325	
	According to setting Day/Night	3421-3425	
		321*	
	According to setting Day/Night	331*	
341*			
According to setting Day/Night	322*		
	332*		
According to setting Day/Night	342*		
Internal code from the phone	Option to choose 1 or 2 digits of code 2 digit code is basic and it is possible to shorten it by using * in the first place of code during programming	351	
		352	
		361	
		362	

Regime m = 4			
Action	Note	Parameter	Relay
Press buttons	Any number other than in 311* or 312*	3114	
		3124	
	Button set in 311* or 312*	3114	
		3124	
Regime m = 6			
Action	Note	Parameter	Relay
Press of the button	Any number other than in 311* or 312*	3116	-
		3126	-
	Button set in 311* or 312*	3116	
		3126	

Note t1 – time of connection of relay 1 (*parameter 371*)
t2 – time between impulses of relay 1 (*parameter 301*)
t3 – time between connections of relay 1 and 2 (*parameter 39*)
t4 - time of connection of relay 2 (*parameter 372*)
t5 - time between impulses of relay 2 (*parameter 302*)

Tab. 1 Table of relay controls

3.3 Person in the building

The person in the building means the person who is in telephone contact with the Brave entry system (i.e. Mr Smith).

3.3.1 Outbound call

An outbound call is a call from the Brave system (i.e. started by a visitor). Once the system has been dialled, a phone inside of the building rings and on pick up it is possible to talk to the visitor at the door. By choosing a code it is possible to switch on a relay (*parameter 35*) if it is set in mode m=1 or m=5, switch over the Day/Night regime (*parameter 45, 46*) and disconnect the connection (*parameter 43*). 10sec before the end of the call (*parameter 52*) the system sends a notice about the end of the call but choosing a code (*parameter 42*) it is possible to pro-long the call. By replacing the handset the call is terminated (the switchboard phone will send a system busy tone and the system will disconnect). There is one more option, disconnection of line after repeat pressing of the same button (*parameter 4**).

3.3.2 Incoming call

An incoming call is a call to the system (started by a person inside the building). After choosing the branch the system is connected and the line rings, following a set number of rings (*parameter 51*) the system will then pick up and it is possible to speak. The options are the same as an 'outgoing call' (chapter 32)



- One exception is in the first 10sec. when it is also possible to input '#' and a service password' (*parameter 44*) directing the system to go to the programming regime.
- Another exception is during incoming call and DIP1 is switched to on ("SERVIS") when the system also goes to the programming regime (without a service password).
- The final exception is relay controls (*parameter 381 a 382*), when an incoming call can disable the relay controls.

3.3.3 Door Entry System with keyboard – module BNSKey

If a keyboard module is connected to the system, then it is necessary to set the following parameters:

- parameter 48 – rank of the keyboard. If it is 'set 0', the keyboard is not there, if it is 'set 1 – 8', then this number represents a position where the keyboard is connected on the BUS (represents the number of flat cables between the keyboard and the basic module).
- parameter 49 – keyboard regime.
 - If it is 0, then the phone number from the keyboard is dialled in the same way as from a phone. The visitor enters a number combination and after a length of time, set by the max time between key presses (*parameter 53*), the Brave picks up and dials the given number.
 - If 1 then the keyboard choses a 2 digit combination 01-99 as per the memory address, where a telephone number is saved. The memory is the same (shared) as the button memory. The number choice depends on the Day/Night setting.
- parameter 40 – choses the DTMF from the keyboard during a call.

Parameter value 40	Meaning of symbol 
0	No DTMF from the keyboard
1	DTMF *
2	DTMF #
3	DTMF A

The keyboard has 2 functioning keys – **key symbol**  = after pressing a number combination can be inputted to control relays. Second key – **symbol X**  = after pressing the system always disconnects.

Choosing number on the keyboard can be done in two ways (*parameter 49*):

- visitor chooses keys like on a phone – the length of time between the presses must be less than the time given in *parameter 53*, after this the system picks up and dials the given number.
- Visitor chooses a 2 digit number (from 01 to 99), which represents a memory number where a number is saved (max. 24 digits long) as per the buttons. The number choice is dependent on the regime setting (i.e. Day/Night) or by regime 2 groups of numbers (as is described in chapter 5.1).

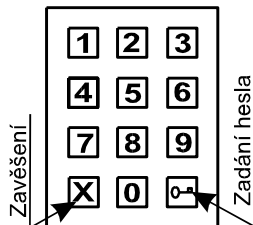

3.4 Acoustic path setting

The principle of setting acoustic paths:

Here we have three parameters 71,72 and 73 Using the interaction of these parameters can be set to sound in different conditions.

1. quiet environment parameters 71,72,73 are set to 7
2. environment where is a strong ambient noise at the communicator and quiet environment at the phone. Here is both necessary to reduce the microphone gain (parameter 72 = 1-3) and also change the ratio of the parameters 71/73 way 73 enlarge the the parameter (parameter 73 = 11-15) and 71 parameter smaller value (71 = 2-4)
3. environment where is a strong ambient noise at the phone and quiet environment at the communicator. Here we leave the parameter value of 72 = 7 and 73 and 71 parameters set as follows - parameter71 = 11 to 14 and 73 = 2 to 4

The principle of settin parameters is - signal from the microphone is amplified by the sum of parameters **72+71 = volume of microphone** and signal to the speaker is amplified by the sum of parameters **71+73 = volume of speaker**. To switch the direction of the ratio is evaluated parameters (**threshold**) 73/72.

- If parameter 72 is greater than the parameter 73, thus favoring the direction from the microphone. We choose when the direction to the phone is interrupted.
- If parameter 73 greater than parameter 72, thus favored direction to the speaker. We choose this if the interrupted sound in the speaker of communicator.

4 Parameter programming

4.1 Programming with the help of a phone

4.1.1 Entry into the programming

There are two ways to enter the Brave's programming system:

1. **With the help of a password** –incoming calls only! – pick up a phone and dial the number that the Brave is connected to (*either the number of the branch, if you are connected to a switchboard line, or the number of the line to the building, where the Brave is and ask be connected to the branch to which the Brave is connected*). The brave will pick up (you will hear the pick-up tone – see chapter 3.1 page 29) within 10 secs. press '**#xxxx**', where xxxx is the service password to enter the programme system (*in the basic setting xxxx=0000*), if correct there will be a programming entry tone followed immediately by a programming tone (see chapter 3.1 page.29).
2. **With the help of DIP 1 "SERVICE"** –incoming call only! – connect to the Brave as in part 1 above, but where the DIP switch is in position 1 "on", the Brave will go straight to the programming regime – you will hear the pick-up tone for entry to programming followed immediately by the programming tone (see chapter 3.1 page.29).
Do not forget to put DIP switch to position "off" at the end.

4.1.2 Parameter programming

The default state for programming is announced with a programming tone, the Brave always returns to this state after a specified time (5sec), whether you started programming or not.

There are two types of parameters used during programming. These are parameters with a **fixed length**, which is the majority of them, when programming is confirmed after it fulfils the mandatory length and is immediately 'written in' with a **confirming tone** and parameters **with variable length** (*parameters 1,2,32,33,34*) when the **confirmation** is made only after time of inaction (5 sec). The only case when there is an immediate 'writing in' of parameters is when the maximum number of 'written in' signs (numbers) are filled up, for parameters 1 and 2 it is 24, for parameters 32,33,34 it is 6.

If you input a number (sign) that is unacceptable during the programming the Brave immediately sends an **error tone**, the parameter is not 'written in' and the Brave reverts to a default state where it is possible to either repeat the parameter programming or start programming a different parameter.

The Brave will automatically disconnect from the programming regime after a period of inaction, 30 sec. With each DTMF tone dialled the time will always resets to 30 sec. It is also possible to end the programming regime by choosing parameter 9.

Note. If you want to keep a connection opened during the programming (prolong the 30 sec time) regime (i.e. before a customer decides what else he wants to be set) then you can press * or #, the Brave immediately answers with an error tone but will prolong the time before disconnecting.

4.2 Programming with the help of a PC – programme BraveSet

To programme the Brave with the PC you will need to use the special cable USB-KAB and programme BraveSet. The Brave will also need to be connected to a telephone line, or with version switched on and connected to an internal power supply 12V - DIP3 and 4.

Procedure:

- Connect the Brave NUDV S2 to the line or with version it is possible to use external power supply 12V (DIP 3,4)
- Connect Brave NUDV S2 to the PC via the USB cable. The Brave will pick up a line and within 3 seconds a tone for programming entry will be heard (see chapter 3.1 Page.29).
- Run programme BraveSet. Until the USB is disconnected the Brave is connected to the PC and is in programming regime and will not run any other operations. If you lose connection, you will need to reconnect the USB cable – the Brave will then pick up.
- Connection between the Brave and the programme is indicated by the firmware on the bottom edge and a time on the upper left, if you have version **(LC)** then the time is nil as the reduced version does not have a RTC circuit.

For ease of orientation the parameters in the BraveSet programme are marked with the same codes as per the phone programming.

The details about parameter setting can be found in 'help' of the programme and also on the manufacturer's website www.alphatech.cz.

5 Description of programmable parameters

Parameters always start with a fixed/mandatory part (address) followed by a variable part, which is your choice. The range and explanation is always under the table, sometimes with examples. Everything is dialled exactly as it is shown in the table, nothing needs to be confirmed in any way, after writing into a memory a confirmation tone can be heard and if an incorrect value is input then an error tone will be heard.

5.1 Direct dialling - memory

Parameter	Value	Meaning	Basic
1	tt nn...	number nn under button tt	-

tt – button number (memory), always input 2 digits [01-99]

nn – telephone number as long as 24 digits that are to be saved. For saving of other sign choices always use the assignation as per the table.

Numbers saved in parameter 1 are numbers of the **first group**, or numbers of the regime **Day**.

Basic settings never change or delete these saved numbers.

meaning	choice
0 - 9	0 - 9
#	#
*	**
Flash	* #
Pause	* 0

Parameter	Value	Meaning	Basic
2	tt nn...	number nn under button tt	-

tt – button number (memory), always input 2 digits [01-99]

nn – telephone number as long as 24 digits that are to be saved. For saving of other sign choices always use the assignation as per the table.

Numbers saved in parameter 2 are numbers of the **second group**, or numbers of the regime **Night**.

Basic setting never change or delete these saved numbers.

meaning	choice
0 - 9	0 - 9
#	#
*	**
Flash	* #
Pause	* 0

Note. The Day/Night regime switch over remains set in the Brave even after a line disconnection, in version this regime switches over according to actual time (if this function is on – parameter 084)

Examples of setting:

1. first button is supposed to dial 358 during the day and 0603441296 during the night, then the programming is - 101358 and wait for 🎵, then 2010 *0 603441296 and wait for 🎵

2. second button is supposed to dial 123#1*2Flash3 during day and night, then the programming is 102123#1 ** 2 *# 3 and wait for ♪, then 202123#1 ** 2 *# 3 and wait for ♪

Note. If you are not using regime Day/night or regime 2 groups of numbers, then it is recommended to set regime Day/Night (*parameter 47*) and then set the same code for switching over Day/Night (*parameters 45 and 46*). His way it is guaranteed that Brave will always be in Day regime and you can only programme telephone numbers for the day regime (*parameter 1*).

5.2 Relays

Parameter	Value	Meaning	Basic
31	r m	relay r operates in regime m (1-8)	11 21

r – relay number [1-2]

m – relay regime [1-8 for r=1 is not regime m=5]

regimes **m=1, 4, 5, 6** are explained in detail in Relay Regimes Tab. 1 on page 32

m=1 mode **relay** – switched on with command (internal code) or with a password (external) 1 impulse for length of time t1/t4 (use for electric locks) or 2 impulses when it switches on for time t1/t4, off for t2/t5 and again switches on for t1/t4 (opening of sliding gates).

m=2 is switched on for time when the line is picked up (**camera**) – switches on when system picks up and off when it disconnects.

m=3 is switched on for time when the line is picked up and extra time t1/t4 after disconnection (**lights**) - switches on for time when the line is picked up and extra time t1/t4 after disconnection state (for this time the line is busy)

m=4 regime **button** – switched on when any button is pressed and off after t1/t4 (use is for example connection of external bell or siren)

m=5 regime **gradual opening** – into this regime it is possible to set only relay 2, because relay 1 will then automatically be set to m=1. With command (internal code) or password (external code) relay 1 is activated for length of time t1, then time t3 is running before relay 2 is switched, then relay 2 is activated for time t4 and after the system disconnects. If given command or password answers to 2 impulses then in the sequence there will be always 2 impulses separated by time t2/t5. Explanation is in Tab.1.

Note. Command or password for relay 1 starts the whole sequence, if you use command or password for relay 2 then only relay 2 is controlled in the same way as in regime m=1.

m=6 switches on depending on pressed button (it is set in parameter 31r*). In this way it is possible to choose only **one button** for each relay, which when pressed switches on relay for time t1/t4. This regime is used instead of connecting separate doorbell to the system.

m=7 permanent switch on / off – only for switching (DIP 3, 4 = on, par. 64=1). With command for 1 impulse it is switched on, for impulse 2 is off. The system remembers its state even after the line is disconnected. This regime is used for watering, green house opening, switching on heating etc.

m=8 switching depends on setting Day/Night – only for switching (DIP 3, 4= on, par. 64=1). Basic version without additional module RTC enables only copying of manual switching Day/Night, but version enables copying of times from the weekly table (if it is on - *parameter 084*) and it is possible to use it for example switching on heating etc.

Parameter	Value	Meaning	Basic
31	r* tt	button tt switches on relay r in regime m=6 (01-99)	01

r – relay number [1-2]

tt – button number (memory), always in two digits [01-99]

This parameter is only for relay regime m=6. Value tt determines which button starts switching on for time t1/t4 of relay r.

Parameter	Value	Meaning	Basic
32	rp hh...	In regime Day + Night password hh... for relay r, in order p=1-5 for 1 impulse and p=* for 2 impulses (00-999999)	-
33	rp hh...	In regime Day password hh... for relay r, in order p=1-5 for 1 impulse and p=* for 2 impulses (00-999999)	-
34	rp hh...	In regime Night password hh... for relay r, in order p=1-5 for 1 impulse and p=* for 2 impulses (00-999999)	-

r – relay number [1-2]

p – order [1 - 5] for 1 impulse. 5 passwords (external codes) from Brave's buttons (external code of code lock)

p – order = * to set password (external code) for 2 impulses

hh... – password (external code) for relay switching on from button or keyboard [2 to 6 places]. Buttons 1 - 10 are programmed as numbers 1-0.

All together 3x12 passwords, depending on the Day/Night setting, combinations are be input either with the help of the buttons (first 10) or from the connected keyboard (after pressing the key sign). Switching on a relay is affected by the relay **regime** and the choice **Day/Night**, if the regime **2 groups of numbers** is set, the system is constantly in regime **DAY**.

There are several rules that needs to be followed when setting a password:

- Choose the first button of password from buttons that are the least used for direct dialling (-prolonging time) (n/a for keyboard).
- Be mindful about conformity of numbers (i.e. when 1 password contains another for example for relay 1 it is 1234 and for relay 2 12345) as the first password will start the action once button 4 is pressed and you will never be able to input button 5 to start action for password 2, and if you choose 234 for a second relay, then after pressing 4 both relays will start.

Note. When setting parameter **32,33,34** signs # and * are not used because they are not on the button panel, number 0 represents button no. 10.

Parameter	Value	Meaning	Basic
35	r aa	command aa from phone for switching relay r 1 impulse (00-99,*0-*9)	155 266

r – relay number [1-2]

aa – command (internal code) for switching on the relay from the phone [2 spaces]^{/1}

To set the same commands for both relays (internal code) so that both relays activate at the same time. It is also recommended that the same command is set for 'relay on' and 'command to disconnection of system (*parameter 43*) **aa=bb**.

^{/1} – command is always 2 digits, but if you wish to control relay with a single digit from the phone, there is an option to input "***a**", where **a** is a single number and the star represents an empty space and must be in the first place.

Example:

1 relay switch on internal code 48 – is programmed **35148** ♪

2 relay switch on internal code 8 - is programmed **352*8** ♪

By choosing no 8 on the phone we switch on just the second relay, with option 48 we switch on both relays

Parameter	Value	Meaning	Basic
36	r cc	command aa from phone for switching relay r 2 impulses (00-99,*0-*9)	150 260

r – relay number [1-2]

cc – command (internal code) for switching on the relay from the phone [2 spaces]^{/1}

To set the same command for both relays (internal code) so that both relays activate at the same time

^{/1} – command is always 2 digits, but if you wish to control relay with a single digit from the phone, there is an option to input "***a**", where **a** is a single number and the star represents an empty space and must be in the first place.

Switching a relay on with 2-impulses is used for sliding gates replacing a gate entry.

Example:

Command for switching on 2 relays 1 impulse is for example *8, the command for disconnection is *8 and the command for switching on 2 relays 2 impulses is *9.

Programming: 352*8 ♪ , 432*8 ♪ , 362*9 ♪.

If you are in conversation with the Brave, the command to open a gate would be button 9, the first impulse starts and the gate opens, the second impulse stops it, the time the gate is opened "opened space" is set by time between the impulses (*parameter 30*) after people enter press 8, then Brave makes 1 impulse and disconnects, gate closes.

Parameter	Value	Meaning	Basic
37	r ss	time ss [sec] of relay r on for time t1/t4 (01-99)	105 205

r – relay number [1-2]

ss – time t1 / t4 for which relay 1 / 2 is switched on [2 spaces 00-99], where time 00 means 0,5sec

Parameter	Value	Meaning	Basic
38	r p	relay r control during incoming call (0/1)	11 21

r – relay number [1-2]

p – parameter whether it is allowed p=1 or disallowed p=0 to control relay during incoming call.

To prohibit 'control' during an incoming call, for use with relay 2 in mode 1 for controlling a garage door, so the electronics open the garage door and the car passing through the door, closes the door. Then control from the phone could result in a permanently opened door (i.e. the door doesn't close because car didn't enter).

Parameter	Value	Meaning	Basic
39	xx	time xx [sec] between switching on relays 1 and 2 in regime m=5 - time t3 (01-99)	10

xx – time t3 between switching on relays 1 and 2 when regime m=5 is set (gradual opening) [2 spaces 00-99] , where time 00 means 0,5sec

Parameter	Value	Meaning	Basic
30	r zz	time zz [sec] between impulses for switching on relay r 2 impulses- time t2/t5 (01-99)	105 205

r – relay number [1-2]

zz – time t2 / t5 between first and second impulse for switching on relay 1 / 2 [2 spaces 00-99], where time 00 means 0,5sec

Parameter	Value	Meaning	Basic
3*	r e	Exit button for relay r (0/1/2)	10 20

r – relay number [1-2]

e – exit button regime: **e=0** - off, **e=1** – on for 1 impulse, **e=2** – on for 2 impulses

Parametr	Value	Description	Default
3#0	p	p = 1 enabled / disabled p = 0 connection code relay COSW (0/1)	0

p – turns on transmission serial code to activate the first switch.

CAUTION - at activation this function never connect to the circuit electric lock without board COSW - code relay - threatens to destroy the relay in Brave communicator!

The following codes may be the same or different for the resolution switching on multiple parallel connected relay code.

Parametr	Value	Description	Default
3#1	abcd	activation code 1 pulse from buttons (0000-1111)	0000

abcd – Brave sends a serial code for the code relay (COSW) after evaluation code from keys (keyboard) namely for 1 pulse

Parametr	Value	Description	Default
3#2	abcd	activation code 1 pulse from phone (0000-1111)	0000

abcd – Brave sends a serial code for the code relay (COSW) after evaluation code from telephone (DTMF) namely for 1 pulse

Parametr	Value	Description	Default
3#3	abcd	activation code 2 pulses from buttons (0000-1111)	0000

abcd – Brave sends a serial code for the code relay (COSW) after evaluation code from keys (keyboard) namely for 2 pulses

Parametr	Value	Description	Default
3#4	abcd	activation code 2 pulses from phone (0000-1111)	0000

abcd – Brave sends a serial code for the code relay (COSW) after evaluation code from telephone (DTMF) namely for 2 pulses

Parametr	Value	Description	Default
3#5	abcd	activation code from other modes of switch (0000-1111)	0000

abcd – Brave sends a serial code for the code relay (COSW) after evaluation code from other modes m switch 1

5.3 Basic parameters

Parameter	Value	Meaning	Basic
41	v	Type of choice v – time/impulse (0/1)	0

v – type of choice **v=0** is DTMF tone choice, **v=1** is impulse choice

Parameter	Value	Meaning	Basic
42	z	Sign for call prolonging (* / #)	*

z – sign for prolonging a call * or # (10secs. before the end of the call the Brave sends signal, after pressing this the Brave prolongs the call)

Parameter	Value	Meaning	Basic
43	g bb	Command for disconnecting Brave from the phone (00-99,*0-*9)	155 266

g – Command order [1-2] (there are 2 to disconnect the Brave from both relays)

bb – Command for disconnecting the Brave from the phone [2 spaces]

/¹ It is advantageous to set the same command for relay switching on (*parameter 35,36*) and command for the Brave disconnection **aa=bb** or **aa=cc**.

/¹ – command is always 2 digits, but if you wish to control relay with a single digit from the phone, there is an option to input "***a**", where **a** is a single number and the star represents an empty space and must be in the first place (*e.g. at parameters 35,36*).

Parameter	Value	Meaning	Basic
44	xxxx	Service password (0000-9999)	0000

xxxx – service password to programme from a phone (DTMF)



If you forget the password, the following procedure is recommended:

1. Open the Brave front cover
2. Switch 'DIP 1' to 'ON'
3. Call the Brave
4. Once the Brave picks up the system is in programming regime. In this regime it is possible to change the password 44xxxx
5. Switch 'DIP 1' to 'OFF' and
6. Close the front cover.

Parameter	Value	Meaning	Basic
45	dd	Command for switch over to DAY (00-99,*0-*9)	11
46	nn	Command for switchover to NIGHT (0099,*0-*9)	10

Dd command to switch over to the **DAY** regime [2 spaces] /¹

Nn command to switch over to the **NIGHT** regime [2 spaces] /¹

/¹ command is always 2 digits, but if you wish to switch over from Day to Night with a single digit from the phone, there is an option to input "***a**", where **a** is a single number and the star represents an empty space and must be in the first place (e.g. parameters 35,36)

Note. The Day/Night switch over regime stays set following line disconnection.

Parameter	Value	Meaning	Basic
47	e	Regime system choice (0/1)	1

e – Choice of regime numbers **e=0** selects numbers from first and second group, **e=1** selects numbers in accordance with the **Day/Night** regime.



WARNING !! setting this parameter materially affects the number dialling!

Parameter	Value	Meaning	Basic
48	c	Keyboard connection (0-8)	0

c – **c=0** connecting the BNSC-mod to the basic module only

c=1 - 8 keyboard connected to the first to eight place



WARNING !! setting this parameter materially affects whole systems function!

Parameter	Value	Meaning	Basic
49	o	Regime keyboard (0/1)	0

- o – o=0 choses a number like a phone (input the whole number)
- o=1 input a 2 digit number (memory) on the keyboard, where the number is saved into the memory (the memory number is the same as button number and respects Day/Night switch over – numbers 01 - 99)



WARNING !! setting this parameter materially affects keyboard function!

Parameter	Value	Meaning	Basic
40	d	Choses DTMF from the keyboard during a call (0-3)	0

- d – d=0 during a call it is **not** possible to dial DTMF from the keyboard
- d=1 DTMF can be dialled, the Key button dials *
- d=2 DTMF can be dialled, the Key button dials #
- d=3 DTMF can be dialled, the Key button dials A

Parameter	Value	Meaning	Basic
4*	k	Line disconnection function by repeatedly pressing a button (0/1)	1

- k – Line disconnection by repeated pressing of the same number:
- k=0 function is disabled and
- k=1 repeatedly pressing the same button to disconnect the line.



WARNING !! setting of this parameter materially affects number dialling!

5.4 Time parameters

Parameter	Value	Meaning	Basic
51	q	Number of rings before the Brave picks up (1-9)	2

- q** – The number of rings before an incoming call is picked up. The Brave picks up between rings 2 secs. after detecting the **q**-th ring. It is possible to set the number of rings between 1 and 9.

Parameter	Value	Meaning	Basic
52	d	Maximum length of a call (0-9,*,#)	2

- d** – The maximum length of time for which the Brave is busy. It is possible to prolong this time during the call by choosing a key (* or #) from the phone (*parameter 42*). The setting of this time is in accordance with the adjacent table.

Time [min]	Option
0,5	0
1 - 9	1 - 9
15	*
30	#

Parameter	Value	Meaning	Basic
53	w	Time between button presses (1-9)	2

- w** – maximum time [in seconds] between button presses [range 1 - 9]

▪ **Normal buttons**

- **Relay switch on** – if the time between presses is longer than time **w**, then the code will not work correctly.
- **Choice of number** – if the pressed button is the first number of a password to switch on a relay then the choice is delayed by time **w**.

▪ **Keyboard**

- **Switch on Relay** – if the time between presses is longer than the time **w** then the code will not work correctly.
- **Choosing of number**
 - Choose from the phone, if the time after the last pressed button is longer than time **w**, then the choice commences, if the number is incomplete, it is necessary to disconnect (press the **X** key ) and repeat the choice
 - Choose from the memory, if the time after the last pressed button is longer than the time **w**, then the choice needs to be repeated.

Parameter	Value	Meaning	Basic
54	z	Time of disconnection for repeat dialling (1-5)	2

z – Time [secs.] the Brave disconnects before it picks up again for repeat dialling (press of a button during a call, detection of busy tone) [range 1-5].

Parameter	Value	Meaning	Basic
55	z	Time before commencing a choice (1-5)	1

z – Time [sec] after the Brave picks up, before it commences a choice [range 1-5]. This time is different for each switchboard phone system, but generally most operate within 2 seconds after a line is picked up.

Parameter	Value	Meaning	Basic
56	hh	Number of rings before it disconnects (04-99)	12

h After the choice finishes it will start counting CRT (control ringing tones), if the number is higher than **hh**, then it will disconnect [range 04-99]. It repeats the choice if the regime of dialling 2 groups of numbers is set.

Parameter	Value	Meaning	Basic
500	x	Medium frequency of tone detector (1-0)	3 (375-475Hz)
501	y	Number of busy tones (2-0)	4
502	z	Time length of permanent tone (1-5)	3 (3s)

- x** Medium frequency of tone detector is set if there is a non-standard signal from the telephone switchboard.
- y** Minimum number of busy tones necessary for detection [2-0], where 0 means 10 busy tones.
- z** Minimum length of time of a permanent tone (for detection of notification tone at branch switchboard) [1-5 sec].

Parameter	Value	Meaning	Basic
503	tt	Tone length of time for DTMF (tone) choice (04-16)	10 (100ms)
504	mm	Time of gap between DTMF tones (04-16)	10 (100ms)
505	f	Length of flash time (1-6)	1 (100ms)
506	p	Length of time of pause/digit gap (1-0)	4 (800ms)

- tt** Length of DTFM tone choices is specified by the formulae:
(the entered number) x 10 = time length of tone [ms]
 [range 04-16 which is 40-160ms]
- m** Length of gap between DTMF tone choices is specified by the formulae:
(the entered number) x 10 = time length of gap [ms]
 [range 04-16 which is 40-160ms]
- f** Length of flash is specified by the formulae:
the entered number x 100 = time length Flash [ms]
 [range 1-6 which is 100-600ms]
- p** Length of pause is specified by the formulae:
the entered number x 100 + 400 = time length of pause [ms]
 [range 1-0 which is 500-1400ms]
 Time **p** is the simultaneously length of gap between button taps for an impulse choice.

frequency [Hz]	x - choice
275-375	1
325-425	2
375-475	3
425-525	4
475-575	5
525-625	6
575-675	7
625-725	8
675-775	9

Parameter	Value	Meaning	Basic
507	uu	Transmit level of DTMF choice v [-dBm] (04-16)	10

uu Transmission level of (DTMF) choice to the line, the range is -4 to -16dBm, input the required level where uu=04 is -4dBm, uu=10 is -10dBm

Parameter	Value	Meaning	Basic
508	p	preemphasis DTMF (0/1)	0
509	S	Listening in DTMF – level (1-4)	2

p Preemphasis is the ratio of the upper and lower groups of DTMF frequencies. It is possible to choose ratio 2.2 dB - p=0 (Europe) or ratio 3.2dB - p=1 (Australia)

s Choice of **DTMF** volume levels (4 levels):

Volume in DTMF [dB]	s - choice
-15	1
-9	2
-3	3
+3	4

5.5 System parameters

Parameter	Value	Meaning	Basic
61	z	Acoustic signals (confirmation, error, empty memory, end of call) (0/1)	1

The Brave's comes with standard acoustic signals. However, using parameter "z" it is possible to switch off the acoustic signals. The values are:

z=0 Acoustic signals **off** and

z=1 Acoustic signals **on**.

Parameter	Value	Meaning	Basic
62	v	Acoustic signals introduction/conclusion (0/1/2)	1

The acoustic signals for the connection and disconnection of a line are standard, but this may cause false choices with some phone systems. So using parameter "v" it is possible to switch off these signals. The values required are:

z=0 Introduction/conclusion signalisation is off

z=1 Pick up and disconnection signalisation on (intro/concl.- type1)

z=2 Pick up and disconnection signalisation on (intro/concl.- type2).

Parameter	Value	Meaning	Basic
63	u	Acoustic ticking signal during a call (0/1)	0

Ticking during a call is switched off as standard. However, by switching it on you can differentiate on the switchboard a call from the Brave by a faint ticking. The values are:

u=0 Ticking into a call is off

u=1 Ticking into a call is on

Parameter	Value	Meaning	Basic
64	w	Internal power supply from connected supply 12V (DIP 3,4) (0/1)	0

The external power supply is turned off as standard.

You only need to turn this function on if the Brave is supposed to operate functions when at rest (i.e. relay control). Relay in regime **m=7** enables permanent switch-on even after call disconnection, regime **m=8** enables switch-on depending on the Day/Nigh setting even after call disconnection. In these cases it is necessary to connect an internal power supply so that there is no current flowing through the Brave when the system is at rest. Switching on of this parameter **w=1** condition switching over DIP switch 3 and 4 to "on". Off - **w=0**.

Parameter	Value	Meaning	Basic
65	z	Acoustic signals for switching on a relay (0/1)	0

The signal for switching on a relay is standard, **z=0**. However, it is possible to use this function when using a uni-directional supply 12V, so when the door lock is open there is **no** buzzing so the person at the door won't know the door is open. When set to **z=1** the time the relay is switched (door open) then there is a specific sound.

Note1 This function is available only for regimes **m=1** and **m=5**

Note2 During the relay switch-on (2 impulses) there is acoustic signal for the whole time of the sequence (even during gap between impulses).

Parameter	Value	Meaning	Basic
66	i	Suppression of the reception DTMF from the microphone (0/1)	0

Suppression of the reception DTMF from the microphone is off as a default **i=0**. It is possible to open the door with a personal dialler without disturbing a person inside the building. For higher security it is possible to switch on the suppression function **i=1** and stop a person with an unauthorised copy of the DTMF code from entering.

Parameter	Value	Meaning	Basic
67	b	Baby Call – call without the need to programme a telephone number (0/1)	0

This function is turned **off** as standard **b=0**. By switching on this function **b=1** the acoustic signal for an empty memory is cancelled, so after pressing a button with an empty memory there is only a beep (confirmation) and a call is activated as if there were a number.

Warning: During the first 10 seconds of a call the tone detector is inactive (there is a pause before the switchboard responds or number dialling by the switchboard).

Parameter	Value	Meaning	Basic
68	b	Mute at the lock activated (0/1)	0

Default is off $m = 0$. By enabling the $m = 1$ mutes the acoustic path at close relay (1 or 2) in "electric lock" (modes 1 and 5). This feature is there because if you often use code lock function or exit button, so the switch-on time to hear the tone exchange. For some customers, this can be distracting.

Parameter	Value	Meaning	Basic
6#	s	Setting of the number of buttons on the main panel.	2

This constant serves a purpose to identify the no.1 button in the composition of the module. After entering the number of buttons **s** the button no 1 is moving so it is always first.

Number of buttons on the main panel	s - choice
0	0
1	1
2	2

 **WARNING !!** setting this parameter materially affects number dialling.

Parameter	Value	Meaning	Basic
6*	t	Delayed start for switchboards with line testing (Siemens) (0/1)	0

This function is off as standard $t=0$. By switching this function on $t=1$ the processor goes into sleep mode immediately after the line connection, and after 3 secs. The Brave initialises. The line connection after the power supply connection is then delayed - state switching on/restarting of the switchboard. If this function is not working and the telephone switchboard still identifies a line fault, then there is no other option but to use an internal power supply, by switching over **DIP** switch **3** and **4** to "on". This measure has the same use as the **Best Box** for older type of communicators.

5.6 Parameter setting Hands Free



First ensure that the rubber seal on the microphone fits properly, otherwise setting the acoustic parameters will be difficult.

Parameter	Value	Meaning	Basic
71	gg	Reception volume 01-16 (16 is the highest) (SPK)	07
72	ff	Transmission volume 01-16 (16 is the highest) (MIC)	07
73	rr	Speaker volume 01-16 (16 is the highest) (TRH)	07

gg/ff/rr Each number is entered as 2 digits with a range 01-16. After receiving a confirmation tone 🎵 the new value is immediately active and can be tested.

Facilitation: you can also add/reduce the volume with help of buttons on the phone * = - and # = +

Stops for the maximum and minimum volume are acoustically signalled (3 tones like the signal for the end of a call). If you don't press anything for 5 seconds then the 'set value' is saved and you hear a confirmation tone 🎵.

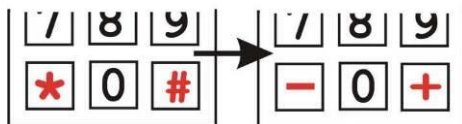

WARNING !! Default values are set by the manufacturer and it is not recommended that you change them unless absolutely necessary.

Parameter	Value	Meaning	Basic
74	c	Soft transition of switch over (0/1)	1

This function is set to **off** as standard **c=0**, it is a character of the semi-duplex operation switch over on the telephone line. If the character of silencing is too steep, it is possible to soften it using **c=1**.

Parameter	Value	Meaning	Basic
75	n	Suppression of background noise (0/1)	1

This function is set to **off** as standard **n=0**. If the Brave is installed in noisy location (train station, busy street, car park etc.) by switching on this circuit **n=1** the noise level is set as a default threshold for switching on the microphone and is not one way opened. This is related to setting of parameters 71, 76, 77.

Parameter	Value	Meaning	Basic
76	b	Threshold for switching on the microphone 1-4 (4 is the highest)	2

There is a simultaneous signal from the microphone and the speaker on the telephone line, to ensure that the Brave doesn't produce acoustic feedback. In the Hands Free circuit there are several functioning blocks for suppressing this feedback. The basic one is a circuit for semi-duplex operation, where the incoming signal weakens the microphone and the signal from the microphone weakens the incoming signal. Thresholds for switching on the microphone are set in this parameter, the lower the value the higher the sensitivity of the microphone. In noisy surroundings it is recommended to use a higher value with combination of parameters 71,75, 77.

Parameter	Value	Meaning	Basic
77	s	Speed of switching over voice atomisation 1-4 (4 is the slowest)	2

Parameters 75, 76 describes the principle of acoustic feedback and the speed with which the circuit switches over, the quality of incoming or outgoing sounds are set with parameter 77.

Switchover time [ms]	s - choice
1	1
2	2
4	3
8	4

Parameter	Value	Meaning	Basic
78	I	VA characteristic for line connection (0/1)	1

Nearly every country in the world has different telephone norms and this parameter enables you to lower the voltage on the Brave's terminals to connect telephone line voltages in active state by 1V. Where it is required the respective norm **I=0** lowers line voltage by 1V, as standard it is **I=1**.

Parameter	Value	Meaning	Basic
79	k	Compensation for loss of conduit depending on line current (0/1/2)	1

The Brave has a circuit for installations remote from the switchboard (>100m) that can compensate for the loss caused by a conduit. This function is switched **off** as standard **k=0**, but it is possible to set on 2 levels, depending on the current that switchboard can supply (short circuit current I_0).

Switchboard current I_0	k - choice
Function off	0
20mA-50mA	1
45mA-75mA	2

Parameter	Value	Meaning	Basic
70	uu	Level of signal transmission v [-dBm] (04-16)	10

uu The signal transmission range to the line is -4 to -16dBm, entered is required level, which is uu=04 is -4dBm, uu=10 is -10dBm ...

5.7 Time programme – automatic switch day/night

Only version with additional module RTC!

Parameter	Value	Meaning	Basic
09	a	Automatic on/off switch over for Day/Night and control of time setting (0/1/#)	0

If the Brave has an RTC circuit - version **(M)**, it possible to switch on the automatic switch over time **a=1**. Condition is correct time setting. It is possible to make easy control **a=#**, the Brave answers either with confirmation tone (all is OK or with an error tone (it is necessary to set the time). Choice **a=0** switches off automatic switch over.

Parameter	Value	Meaning	Basic
081	hhnn	Time setting hh-hours, nn-minutes	-
082	ddmm yyw	Date setting dd-day,mm-month,yy-year, w-day of the week	-
083	#	Waits 1 minute to reset to zero seconds	-

Setting of time parameters of internal clock. After setting it is possible to witch command **083#** zero sec and exactly reconcile clock to the sec. w is number representing day of the week [0-6], where 0 is Sunday and 6 is Saturday

Day of the week	Sunday	Monday	Tuesday	Wednesday	Thursday	Friday	Saturday
w	0	1	2	3	4	5	6

Example: to set 27.5.2011 Friday 9:39, the sequence is:

0822705115 listen for tone ♪, then 0810939 listen for tone ♪ and finally 083 – wait for exact time sec=0, in this moment choose # and hear tone ♪ - finished.

Parameter	Value	Meaning	Basic
00	hhnnkkjj	Sunday – time setting hours hh and minutes nn starts day and hours kk and minutes jj starts night	00000000
01	hhnnkkjj	Monday - time setting hours hh and minutes nn starts day and hours kk and minutes jj starts night	00000000
02	hhnnkkjj	Tuesday - time setting hours hh and minutes nn starts day and hours kk and minutes jj starts night	00000000
03	hhnnkkjj	Wednesday - time setting hours hh and minutes nn starts day and hours kk and minutes jj starts night	00000000
04	hhnnkkjj	Thursday - time setting hours hh and minutes nn starts day and hours kk and minutes jj starts night	00000000
05	hhnnkkjj	Friday - time setting hours hh and minutes nn starts day and hours kk and minutes jj starts night	00000000
06	hhnnkkjj	Saturday - time setting hours hh and minutes nn starts day and hours kk and minutes jj starts night	00000000
07	#	overwrites (copies) setting from Sunday (00) to the whole week	-

In parameters 00-06 automatic Day/Night switch over times are set for each day of the week. Parameter 07 is used when it is not necessary to programme the whole week if the times are the same, then it is enough to programme 00 (Sunday) and with parameter 07# this setting will be copied to the rest of the week.

Examples:

1. On Monday at 8:00 day starts, 17:05 night starts, Tuesday at 7:30 day starts and at 16:00 night starts

Programming sequence: 0108001705 and ♪, then 0207301600 and ♪

2. On Thursday day starts at 6:45 and night starts at 15:05, on Friday night continues till 15:00 when day starts and continues until Saturday 12:00 and then it is night again. Here it is possible to use setting in the frame of one day switching over day to the night even though the night is already on since the previous day and again to the day even though day is on from the previous day, then for time setting over midnight a time 00:00 is entered.

Programming sequence: 0406451505 and ♪, 0515000000 and ♪, 0600001200 and ♪

5.8 Basic setting and deletion

Parameter	Value	Meaning	Basic
8#	#	Basic setting	provide

This setting does not affect parameters 1 and 2 (numbers saved in memory)

Parameter	Value	Meaning	Basic
81		Deletes all numbers in 1st group (regime Day)	
82		Deletes all numbers in 2nd group (regime night)	
83		Basic setting only for parameters 3x	only 3..
84		Basic setting only for parameters 4x	only 4..
85		Basic setting only for parameters 5x	only 5..
86		Basic setting only for parameters 6x	only 6..
87		Basic setting only for parameters 7x	only 7..
80		Basic setting only for parameters 0x	only 0..

Parameters 81 and 82 deletes all numbers saved in the button memory.

Parameters 83 – 87,80 deletes selective basic setting for parameters starting with 3,4,5,6,7,0. Values for the basic setting are stated for each parameter in the right hand - column "Basic".

 **WARNING !!!** deletion is irreversible and it would be necessary to reprogramme them again!

5.9 End of programming

Parameter	Value	Meaning	Basic
9		E N D of programming	

After choosing 9 programming tone the Brave disconnects.

5.10 Parameter overview

Parameter	Value	Meaning	Basic
1	tt nn...	number nn under button tt	-
2	tt nn...	number nn under button tt	-
31	r m	relay r works in regime m (1-8)	11 21
31	r* tt	button tt causes switching on of relay r in regime m=6 (01-99)	01
32	rp hh...	In regime DAY + NIGHT password hh... for relay r , in order p=1-5 , for 1 impulse and p=* for 2 impulses (00-999999)	-
33	rp hh...	In regime DAY password hh... for relay r , in order p=1-5 , for 1 impulse and p=* for 2 impulses (00-999999)	-
34	rp hh...	In regime NIGHT password hh... for relay r , in order p=1-5 , for 1 impulse and p=* for 2 impulses (00-999999)	-
35	r aa	command aa from the phone for switching on relay r 1 impulse (00-99,*0-*9)	155 266
36	r cc	command aa from the phone for switching on relay r 2 impulses (00-99,*0-*9)	150 260
37	r ss	time ss [sec] of relay r switch on for time t1/t4 (01-99)	105 205
38	r p	Control of relay r during incoming call (0/1)	11 21
39	xx	period xx [sec] between switching on of relays 1 and 2 in regime m=5 – time length t3 (01-99)	10
30	r zz	period zz [sec] between impulses for switching on 2 impulses of relay r – time length t2/t5 (01-99)	105 205
3*	r e	Exit button for relay r (0/1/2)	10 20
3#0	p	p = 1 enabled / disabled p = 0 connection code relay COSW (0/1)	0
3#1	abcd	activation code 1 pulse from buttons (0000-1111)	0000
3#1	abcd	activation code 1 pulse from phone (0000-1111)	0000
3#1	abcd	activation code 2 pulses from buttons (0000-1111)	0000
3#1	abcd	activation code 2 pulses from phone (0000-1111)	0000
3#5	abcd	activation code from other modes of switch (0000-1111)	0000
41	v	Type of choice v – ton/impulse (0/1)	0

42	z	Sign for call prolonging (* / #)	*
43	g bb	Command for Brave disconnection from the phone (00-99,*0-*9)	155 266
44	xxxx	Service password (0000-9999)	0000
45	dd	Command for switch over to DAY (00-99,*0-*9)	11
46	nn	Command for switch over to NIGHT (0099,*0-*9)	10
47	e	Regime system choice (0/1)	1
48	c	Keyboard connection (0-8)	0
49	o	Keyboard regime (0/1)	0
40	d	Choice DTMF from the keyboard during a call (0-3)	0
4*	k	Line disconnection by repeat press of the same button (0/1)	1
51	q	Umber of rings before Brave picks up (1-9)	2
52	d	Maximum length of call (0-9,*,#)	2
53	w	Time between button presses (1-9)	2
54	z	Time of disconnection for repeat choice (1-5)	2
55	z	Time before choice begins (1-5)	1
56	hh	Number of rings before disconnection (04-99)	12
500	x	Medium frequency of tone detector (1-0)	3 (375-475Hz)
501	y	Number of busy tones (2-0)	4
502	z	Length of time for permanent tone (1-5)	3 (3s)
503	tt	Length of time for DTMF (tone) choice (04-16)	10 (100ms)
504	mm	Length of time for gap between DTMF tones (04-16)	10 (100ms)
505	f	Length of time Flash (1-6)	1 (100ms)
506	p	Length of time for pause/inter-digit gap (1-0)	4 (800ms)
507	uu	Level of transmission of DTMF choice v [-dBm] (04-16)	10
508	p	preemphasis DTMF (0/1)	0
509	S	Listening in DTMF – level (1-4)	2
61	z	Acoustic signalisation (confirmation, error,	1

		empty memory, end of call...) (0/1)	
62	v	Acoustic signalisation Intro/Concl. (0/1)	1
63	u	Acoustic signalisation ticking into a call (0/1)	0
64	w	Internal power supply from connected supply 12V (DIP 3,4) (0/1)	0
65	z	Acoustic signalisation for relay switch on (0/1)	0
66	i	Suppression of reception DTMF from microphone (0/1)	0
67	b	Baby Call – call without the need to programme in number (0/1)	0
68	b	Mute at the lock activated (0/1)	0
6#	s	Setting of number of buttons on the main panel	2
6*	t	Delayed start for switchboards with line tests (Siemens) (0/1)	0
71	gg	Reception volume 01-16 (16 is the highest) (SPK)	07
72	ff	Transmission volume 01-16 (16 is the highest) (MIC)	07
73	rr	Speaker volume 01-16 (16 is the highest) (TRH)	07
74	c	Soft transition of switchover (0/1)	1
75	n	Suppression of background noise (0/1)	1
76	b	Threshold for switching on the microphone 1-4 (4 is the highest)	2
77	s	Speed of switching over voice atomisation 1-4 (is the slowest)	2
78	l	VA characteristic for line connection (0/1)	1
79	k	Compensation for loss of conduit depending on line current (0/1/2)	1
70	uu	Level of signalisation transmission in [-dBm] (04-16)	10
09	a	Switching on/off of automatic switch over Day/Night and control of time setting (0/1/#)	0
081	hhnn	Time setting hh-hours, nn-minutes	-
082	ddmmyy yw	Date setting dd-day,mm-month,yy-year, w-day of the week	-
083	#	Waits 1 sec for zero sec	-
00	hhnnkkj j	Sunday – time setting hours hh and minutes nn starts day and hours kk and	00000000

		minutes jj starts night	
01	hhnnkkj j	Monday - time setting hours hh and minutes nn starts day and hours kk and minutes jj starts night	00000000
02	hhnnkkj j	Tuesday - time setting hours hh and minutes nn starts day and hours kk and minutes jj starts night	00000000
03	hhnnkkj j	Wednesday - time setting hours hh and minutes nn starts day and hours kk and minutes jj starts night	00000000
04	hhnnkkj j	Thursday - time setting hours hh and minutes nn starts day and hours kk and minutes jj starts night	00000000
05	hhnnkkj j	Friday - time setting hours hh and minutes nn starts day and hours kk and minutes jj starts night	00000000
06	hhnnkkj j	Saturday - time setting hours hh and minutes nn starts day and hours kk and minutes jj starts night	00000000
07	#	overwrites (copies) setting from Sunday (00) to the whole week	-
8#	#	Basic setting	provide
81		Deletes all numbers in 1st group (regime Day)	
82		Deletes all numbers in 2nd group (regime night)	
83		Basic setting only for parameters 3x	only 3..
84		Basic setting only for parameters 4x	only 4..
85		Basic setting only for parameters 5x	only 5..
86		Basic setting only for parameters 6x	only 6..
87		Basic setting only for parameters 7x	only 7..
80		Basic setting only for parameters 0x	only 0..
9		E N D	

6 Technical parameters

6.1 Electrical parameters

Parameter	Value	Conditions
Minimum line current	18mA	Line picked up
Minimum line voltage	18V	Line disconnected
Voltage on the line when Brave picks up (VA characteristic)	< 8V < 12V ¹⁾	I = 20mA I = 60 mA
Lead in in disconnected state	< 30uA	U = 60V
Impedance of line ending	220R + 820R paral. 115nF	Line picked up
Bandwidth	300Hz – 3400 Hz	20 - 60mA
Impedence of ringing	> 2Kohm	25 – 60 Hz
Sensitivity of ringing detector	min. 10 – 25 V	
Impulse choice	40 / 60 ms	
Level of tone choice	-6 a -8 dB ¹⁾	20 – 60 mA
Sensitivity of tone choice	min. -40 dB	20 – 60 mA
Sensitivity of tone detector	min. -30 dB	20 – 60 mA
Power supply for name tag back lighting, relay, heating and current circuit for exit button	12V DC(11V-24V) , 12V AC(10V-18V)	
Max off take of backlighting and heating	250mA	12Vss
Max. Voltage of relay contact	48V	When I < 1A
Max. Current of relay contact	1,5A	When U < 30 V
Operating temperature	- 20 to + 60 st.	
Level of cover	IP45	
Weight	Depends on variation and composition	

1) Potential to change by programming.

6.2 Mechanical dimensions

Type of item	dimensions HxWxL [mm]			
	1 module	2 modules	3 modules	4 modules
Module	90 x 90			
Assembly box (1148/4x)	118x118x45	208x118x45	298x118x45	388x118x45
Frame cover (1148/6x)	127x125x12	217x125x12	307x125x12	397x125x12
Roof (1148/61x)	152x157x50	242x157x50	332x157x50	422x157x50
Rain cover (1148/31x)	152x157x79	242x157x79	332x157x79	422x157x79

7 Table for easy programming

Fill in the values you want to programme into the empty part of the table, in the double framed part there are whole programming commands to make programming easier. You can keep the programmed values in the manual for future changes.

Meaning		Programming sequence		No of spaces
description	specify	par.	Fill the values	
Number under button 1	Day/1gr.	101		24
Number under button 2	Day/1gr.	102		24
Number under button 3	Day/1gr.	103		24
Number under button 4	Day/1gr.	104		24
Number under button 5	Day/1gr.	105		24
Number under button 6	Day/1gr.	106		24
Number under button 7	Day/1gr.	107		24
Number under button 8	Day/1gr.	108		24
Number under button 9	Day/1gr.	109		24
Number under button 10	Day/1gr.	110		24
Number under button 11	Day/1gr.	111		24
Number under button 12	Day/1gr.	112		24
Number under button 1	Night/2gr.	201		24
Number under button 2	Night/2gr.	202		24
Number under button 3	Night/2gr.	203		24
Number under button 4	Night/2gr.	204		24
Number under button 5	Night/2gr.	205		24
Number under button 6	Night/2gr.	206		24
Number under button 7	Night/2gr.	207		24
Number under button 8	Night/2gr.	208		24
Number under button 9	Night/2gr.	209		24
Number under button 10	Night/2gr.	210		24
Number under button 11	Night/2gr.	211		24
Number under button 12	Night/2gr.	212		24
relay 1 works in mode	m=1 - 8	311		1
Relay 2 works in mode	m=1 - 8	312		1
Passw. for relay 1 (1 imp.)	Day+Night	3211		6

Passw. for relay 1 (1 imp.)	Day+Night	3212		6
Passw. for relay 1 (1 imp.)	Day+Night	3213		6
Passw. for relay 1 (1 imp.)	Day+Night	3214		6
Passw. for relay 1 (1 imp.)	Day+Night	3215		6
Passw. for relay 1 (2 imp.)	Day+Night	321*		6
Passw. for relay 2 (1 imp.)	Day+Night	3221		6
Passw. for relay 2 (1 imp.)	Day+Night	3222		6
Passw. for relay 2 (1 imp.)	Day+Night	3223		6
Passw. for relay 2 (1 imp.)	Day+Night	3224		6
Passw. for relay 2 (1 imp.)	Day+Night	3225		6
Passw. for relay 2 (2 imp.)	Day+Night	322*		6
Passw. for relay 1 (1 imp.)	Day	3311		6
Passw. for relay 1 (1 imp.)	Day	3312		6
Passw. for relay 1 (1 imp.)	Day	3313		6
Passw. for relay 1 (1 imp.)	Day	3314		6
Passw. for relay 1 (1 imp.)	Day	3315		6
Passw. for relay 1 (2 imp.)	Day	331*		6
Passw. for relay 2 (1 imp.)	Day	3321		6
Passw. for relay 2 (1 imp.)	Day	3322		6
Passw. for relay 2 (1 imp.)	Day	3323		6
Passw. for relay 2 (1 imp.)	Day	3324		6
Passw. for relay 2 (1 imp.)	Day	3325		6
Passw. for relay 2 (2 imp.)	Day	332*		6
Passw. for relay 1 (1 imp.)	Night	3411		6
Passw. for relay 1 (1 imp.)	Night	3412		6
Passw. for relay 1 (1 imp.)	Night	3413		6
Passw. for relay 1 (1 imp.)	Night	3414		6
Passw. for relay 1 (1 imp.)	Night	3415		6
Passw. for relay 1 (2 imp.)	Night	341*		6
Passw. for relay 2 (1 imp.)	Night	3421		6
Passw. for relay 2 (1 imp.)	Night	3422		6
Passw. for relay 2 (1 imp.)	Night	3423		6
Passw. for relay 2 (1 imp.)	Night	3424		6
Passw. for relay 2 (1 imp.)	Night	3425		6
Passw. for relay 2 (2 imp.)	Night	342*		6

Button choice for 1 relay	m=6	311*	2
Button choice for 2 relay	m=6	312*	2
Switch on r 1 from phone	1 impulse	351	2
Switch on r 2 from phone	1 impulse	352	2
Switch on r 1 from phone	2 impulses	361	2
Switch on r 2 from phone	2 impulses	362	2
Length of time for r 1 switch on	[sec]	371	2
Length of time for r 2 switch on	[sec]	372	2
Control of r 1 during incoming call	1 / 0	381	1
Control of r 2 during incoming call	1 / 0	382	1
Length of time between switch on r 1 and 2	[sec]	39	2
Length of time between impulses of r 1	[sec]	301	2
Length of time between impulses of r 2	[sec]	302	2
Exit button for r 1	0/1/2	3*1	1
Exit button for r 2	0/1/2	3*2	1
Enable code relay (COSW-sw.1)	0/1	3#0	1
code for activation 1 imp./btn.	0000-1111	3#1	4
code for activation 1 imp./phn.	0000-1111	3#2	4
code for activation 2 imp./btn.	0000-1111	3#3	4
code for activation 2 imp./phn.	0000-1111	3#4	4
code for activation other mode	0000-1111	3#5	4
Type of choice tone / imp.	0 / 1	41	1
Sign for prolonging of call	* / #	42	1
Brave disconnection from phone	1.	431	2
Brave disconnection from phone	2.	432	2
Service password		44	4
Command for switch over to DAY		45	2
Command for switch over to NIGHT		46	2
Regime system choice	1 / 0	47	1
Keyboard connection	0/1-8	48	1
Keyboard regime	1 / 0	49	1

choice DTMF from keyboard	0/1/2/3	40		1
Disconnection by repeat press of the same button	0 / 1	4*		1
Number of rings for pick up		51		1
Maximum length of time	[min]	52		1
Time between button presses	[sec]	53		1
Time of disconnection for repeat choice	[sec]	54		1
Time before choice commences	[sec]	55		1
Number of rings before disconnection		56		2
Frequency of tone detector	table	500	ms	1
Number of busy tones		501		1
Length of time of permanent tone		502	sec	2
Length of time of tone choice	nn x 10	503	ms	2
Gap between DTMF tones	nn x 10	504	ms	2
Length of time Flash	n x 100	505	ms	1
Length of time of pause / gap	n x100+400	506	ms	1
Transmitting level DTMF	04-16	507	-dBm	2
preemphasis DTMF	0 / 1	508		1
Listening in DTMF - level	1-4	509		1
Acoustic signalisation (other)	0 / 1	61		1
Acoustic signalisation Intro/Concl.	0 / 1	62		1
Acoustic sign. ticking	0 / 1	63		1
Internal power supply from 12V	0 / 1	64		1
Signal tone turning on relay	0 / 1	65		1
Suppression of reception from microphone	0 / 1	66		1
Baby Call	0 / 1	67		1
Mute at the lock activated	0 / 1	68		1
no of buttons on the panel	Type dependant	6#		1
Delayed start (Siemens)		6*		1
Reception volume (TRH)	01-16	71		2
Transmitting volume (MIC)	01-16	72		2

Speaker volume (SPK)	01-16	73		2
Soft transition of switch over	0 / 1	74		1
Suppression of background noise	0 / 1	75		1
microphone switch on threshold	1 - 4	76		1
Speed of switching over voice atomization	1 - 4	77		1
VA characteristic	0 / 1	78		1
Compensation for loss of conduit	0 / 1 / 2	79		1
Level of signalisation transmission	04 - 16	70	-dBm	2
On/off automatic switch over	0 / 1 / #	09		0
Time setting	hhnn	081		4
Date setting	ddmmyy	082		6
Sunday	hhnnkkjj	00		8
Monday	hhnnkkjj	01		8
Tuesday	hhnnkkjj	02		8
Wednesday	hhnnkkjj	03		8
Thursday	hhnnkkjj	04		8
Friday	hhnnkkjj	05		8
Saturday	hhnnkkjj	06		8

*note. hours **hh** and minutes **nn** starts **day** and hours **kk** and minutes **jj** starts **night***

WARRANTY:

Each and every product has been tested before it leaves the factory.

The manufacturer guarantees that the product and its features will work in accordance with the descriptions in this manual as long as the customer uses the product in accordance with the manufacturer's instructions.

Warranties will be extended when a warranty repair has been undertaken.

Although all warranty repairs will be handled by the manufacturer it is important that warranty claims are handled through your dealer. Warranty claims should be accompanied by:

- The product in question
- A description of the problem
- Proof of purchase and
- Your full name and address.

The warranty does not cover:

- Mechanical, chemical, thermal or any other faults cause by the user
- Faults caused by natural disasters
- Faults caused by repairs or changes made by the user or any other authorised or unauthorised person(s)
- Purposely done damage
- Incorrect use of the product, caused by incorrect installation, programming etc., and
- Damages cause during the transport of the product to and from the purchaser.

Manufacturer:

Dealer:

Date of sale:

ALPHA
Tech

© JR 2011-17 Version 1.1 V/17